

AIRSTREAM TRAILER SERIAL NUMBER:

MODEL: 1966 OVERLANDER TWIN 26 FT.

DIMENSIONS:

OVERALL LENGTH _____ 26'8"

OVERALL WIDTH _____ 96"

OVERALL HEIGHT _____ 106"

WEIGHT: 4250 LBS.

HITCH WEIGHT: 400 LBS.

SPECIFICATIONS SUBJECT TO CHANGE

If and when new materials and production techniques are developed which can improve the quality of its product, Airstream, Inc., reserves the right to make changes in the specifications printed herein.

SPECIFICATIONS:

BRAKES _____ 2 SETS, KELSEY-HAYES, ELECTRIC

WHEELS _____ 4, 15" DROP CENTER

TIRES _____ 4, 7:00x15, 6-PLY NYLON, TUBELESS

BRAKE CONTROL _____ 12-VOLT, KELSEY-HAYES

HITCH BALL _____ 2" MARVEL

FLOOR PLAN:

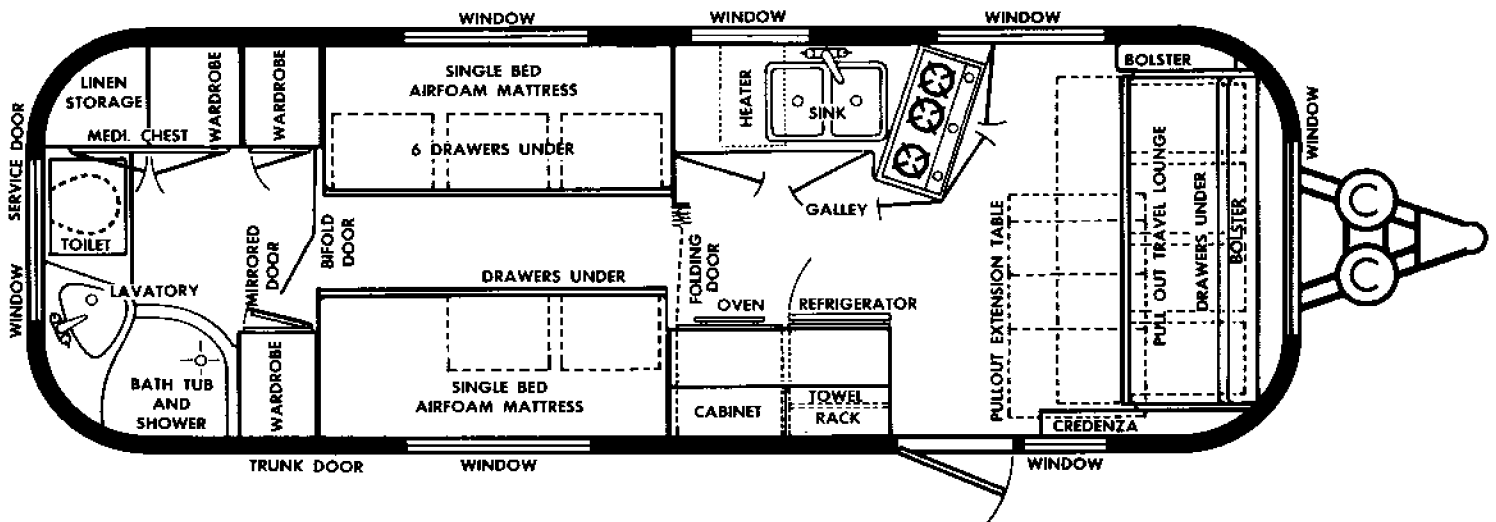

TABLE OF CONTENTS

	Page
Foreword	I
Factory Service Procedure.....	II
Wally Byam Caravans and Caravan Clubs.....	III
 SECTION I — TRAVEL TRAILERING	
Chapter 1 — Getting Acquainted with your Airstream.....	1-1
Chapter 2 — Getting Ready For The Road.....	2-1
Chapter 3 — Towing Your Airstream.....	3-1
Chapter 4 — Stopping For The Night.....	4-1
Chapter 5 — Making an Extended Stay.....	5-1
 SECTION II — THE SELF-CONTAINED UTILITIES IN YOUR AIRSTREAM	
Chapter 6 — The LPG (Liquid Petroleum Gas) System.....	6-1
Chapter 7 — The Range and Oven.....	7-1
Chapter 8 — The Refrigerator	8-1
Chapter 9 — The Furnace.....	9-1
Chapter 10 — The Water Heater.....	10-1
Chapter 11 — The Electrical System.....	11-1
Chapter 12 — The Water System.....	12-1
Chapter 13 — The Sewage System.....	13-1
 SECTION III — MAINTAINING YOUR AIRSTREAM	
Chapter 14 — Exterior Maintenance	14-1
Chapter 15 — Interior Maintenance.....	15-1
Chapter 16 — Winterizing	16-1
Chapter 17 — The Windows	17-1
Chapter 18 — The Running Gear	18-1

oreword

When you took delivery on your new Airstream, the dealer explained to you the operation of all of the appliances and systems in your trailer, and gave you some tips on getting more fun out of travel trailering. This Manual will serve two purposes: It has tips on travel trailering drawn from the experiences of tens of thousands of people like you . . . who have taken their Airstreams into every corner of the earth. In addition, it contains operating and maintenance instructions which you will want to refer to from time to time to supplement the instructions your dealer gave you.

Should you trade or sell your trailer, be sure to pass this Manual along to the new owner; when you've read it through, you'll know how valuable it can be in getting better acquainted with the Airstream.

When you bought your Airstream you not only received the finest travel trailer ever built, you entered a new way of life . . . a way of life filled with new friends and adventures to come. Those who travel the byways of the world in their Airstreams are called Caravanners and they never say "Goodbye," they simply say "We'll be seeing you on the road."

AIRSTREAM INC.

Lifetime Warranty

THIS TRAILER IS GUARANTEED FOR THE LIFE OF THE PURCHASER UNDER THE AIRSTREAM INC. WARRANTY

AIRSTREAM, INC. warrants each new travel trailer manufactured by it to be free from defects in labor and material as manufactured.

In the event of the existence of defects in labor or material, Airstream will cure and correct each defective condition without cost or obligation to the original owner purchasing from an authorized Airstream dealer upon terms and conditions as herein set forth. If the defective part or the trailer is delivered to an Airstream factory or to a designated dealer, and if Airstream or said designated dealer determines labor or material to have been defective as manufactured, said defective condition will be cured and corrected provided the original purchaser is the then owner of the travel trailer.

Immediately upon completion of repairs or replacement, it shall be the obligation of the original owner to remove the replaced or repaired part or repaired trailer.

By accepting this Warranty, buyer expressly waives any and all other warranties, whether express or implied, and waives any and all other obligations and liabilities, if any, on the part of Airstream, or on the part of the selling dealer.

By accepting this Warranty, buyer recognizes and acknowledges that the dealer is an entity independent and separate from Airstream, and that any statements, representations or warranties made by the dealer, are not statements, representations or warranties made by Airstream.

This Warranty shall continue in full force and effect so long as the travel trailer to which it pertains is owned by the original purchaser from the Airstream dealer.

This Warranty does not apply to the following: Changes; modifications; alterations; replacements; or repairs, except such as have been made by an Airstream factory or any of its designated dealers in fulfilling the obligations of this Warranty.

Expressly and specifically excluded from this Warranty are the following: Damage caused by overloading; Natural or normal deterioration; Changes affecting the stability of the trailer; The entire axle and wheel assembly; brake assembly; refrigeration; heating stove; ranges; electrical fixtures; water heaters; or other trade accessories manufactured by a company other than Airstream, and installed as a unit in an Airstream trailer.

AIRSTREAM INC.

J 1266 236

Serial No.

By _____

IMPORTANT: *Unless the registration certificate attached hereto is signed by the Airstream dealer and customer and filed and registered at an Airstream factory within thirty (30) days from the date of the original sale, this lifetime warranty shall not be of any force nor effect.*

Factory rated axle load capacity of this unit in pounds per axle is 2700

FACTORY SERVICE

Airstream's policy has always been to provide the highest degree of service for Airstream owners. To this end, Airstream originated the lifetime warranty in the travel trailer industry.

A facsimile copy of the Airstream Lifetime Warranty is bound into this manual. Upon your taking delivery, the dealer should sign the attached return postcard in the place designated and mail it to the factory for proper registration of your warranty. The facsimile copy is for you to read so that you will understand the exact coverage of the warranty. As soon as the postcard is received, the permanent registered copy of the warranty for your trailer will be sent to you.

Please note that your warranty will not be in effect until it is registered, and that Airstream Factory Authorized Certified Service Centers are not authorized to

provide service under the Lifetime Warranty unless it can be produced at the time the service is performed. If and when the occasion arises that you require service on your trailer, we suggest that you first contact your dealer. If the service is minor, or simply involves an adjustment, he will perform the service. Service and repair depots are listed under the various appliance sections of this manual which will provide service under their respective warranties.

For major service under your Airstream Warranty, Airstream Trailers, Inc. has established a nationwide network of Factory Authorized Certified Service Centers, staffed with factory-trained service specialists. For prompt service simply present your Airstream Lifetime Warranty to any of the Factory Authorized Certified Service Centers listed below.

FACTORY AUTHORIZED CERTIFIED SERVICE CENTERS

ARIZONA

Robert Crist and Company
1665 East Main St.
Mesa, Arizona

CALIFORNIA

Boyer Trailer Sales
6668 Long Beach Blvd.
N. Long Beach, California
Caravan Trailer Sales
730 Fletcher Parkway
El Cajon, California
El Camino Trailer Sales
2090 El Camino Real
Mountain View, California
Vet's Sales and Service
416 South Mt. Vernon Ave.
San Bernardino, California

COLORADO

Chisman Trailer Sales
2500 E. Boulder St.
Colorado Springs, Colorado
Denver Trailer Sales
1746 South Broadway
Denver, Colorado

DELAWARE

Richard Rice, Inc.
601 South Dual Highway
Seaford, Delaware 19973

FLORIDA

Jerry's Travel Trailer Sales
& Service
2710 North West 36th Street
Miami, Florida 33142
C. J. Stoll, Inc.
5985 34th Street, North
St. Petersburg, Florida 33714

ILLINOIS

Robert Crist and Company
9100 South Stony Island Ave.
Chicago, Illinois 60617
Hunter Motors, Inc.
415 North Illinois Avenue
Carbondale, Illinois 62901
Mann's Mobile Homes
R. R. #1, North Normal, US 51
Normal, Illinois 61761
Ray's Travel Trailers
7135-49 W. Irving Park Road
Chicago, Illinois 60634

INDIANA

US 24 Trailer Sales
US Rte. 24 — East of Roanoke
Roanoke, Indiana 46783

IOWA

Bill Brown Trailer Sales
3700-3708 E. 14 St.
Des Moines, Iowa 50313

MAINE

Files & O'Keefe of Maine Inc.
P.O. 879 — Forest Avenue Ext.
Portland, Maine 04103

MICHIGAN

Kolbe Trailer Sales
5785 E. Eight Mile Road
Warren (Detroit) Michigan 48091
Mid-State Trailer Sales
1616 North Saginaw Road
Midland, Michigan 48642
Northwoods Trailer Sales
G-6369 North Dort Highway
Mt. Morris, Michigan 48458
Warner Trailer Sales, Inc.
3098 W. Huron Street
Pontiac, Michigan 48054

MINNESOTA

Phil Dunning Trailer Sales
3050 Coon Rapids Blvd.
Coon Rapids, Minnesota 55433
Ted's Pioneer Trailer Sales
Highway 218 South
Austin, Minnesota 55912

NEBRASKA

A. C. Nelsen Company
2112 Harney St.
Omaha, Nebraska

NEVADA

"95" Trailer Sales
4339 Tonopah Highway
Las Vegas, Nevada

NEW JERSEY

South Jersey
Travel Trailer Center
Delsea Drive
Iona, New Jersey 08325

NEW YORK

Eastern Travel Trailers, Inc.
204 Vestal Parkway East
Vestal, New York 13850
Maroon Airstream Travel
Trailers, Inc.
2550 Walden Avenue
Exit 52, East from NY Thruway
Buffalo, New York 14225
Niblack Trailer Sales
691 McLean Avenue
Yonkers, New York
O'Malley Enterprise, Inc.
P.O. 116 — Traffic Circle,
Rts. 9 & 7
Latham, New York 12110

NORTH CAROLINA

Faires, Inc.
P.O. 5205 — Routes 29 & 49
Charlotte, North Carolina 28206

Out of Doors Mart
3686 Reynolda Road
Rt. 67 North
Winston-Salem,
North Carolina 27106

OHIO

Louisville Airstream Sales
1001 W. Main Street
Louisville, Ohio 44641

OKLAHOMA

Brassfield's Mobilehomes
7207 N. W. 39th Expressway
Bethany, Oklahoma

OREGON

Cascade-Pacific Trailer Sales
1876 Highway 99 North
Eugene, Oregon

PENNSYLVANIA

Curry Airstream Sales
848 W. Chocolate Avenue
Hershey, Pennsylvania 17033

TENNESSEE

Cullum's Sales & Service Center
160 McGavock Pike
Donelson, Tennessee 37203

TEXAS

Wallace Land Yacht Sales
& Service
2005 Mangum
Houston 18, Texas

VIRGINIA

Travel Trailers of Virginia
P.O. Box 807
2211 South Main Street
Harrisonburg, Virginia 22801

WASHINGTON

Birch Bay Trailer Sales
Route 1, Box 106
Blaine, Washington
Central Trailer Exchange
14433 Pacific Highway South
Seattle 68, Washington

WISCONSIN

Liebszeit Mobile Homes &
Travel Trailers
4110 W. Wisconsin Avenue
Route 41 & 10
Appleton, Wisconsin 54914
Northside Mobile Homes
7525 West Appleton Avenue
Milwaukee, Wisconsin 53216

CANADA

Dyke's Caravans
St. Luc (Rts. 7 & 9B)
CO St. Jean, P. Q. Canada

Of course each Airstream plant maintains a very complete service department to take care of your major service needs. But in order to service customers most expeditiously it is necessary that these service departments be operated on a scheduled appointment basis.

Service Manager Airstream, Inc.
12804 E. Firestone Blvd.
Santa Fe Springs, Calif. 90670
(213) 868-3748

Please communicate with either of the Service Managers when you intend to visit the factory, and request an appointment for service. It is beneficial also to advise the Service Managers when you are unable to meet the appointment date.

or
Service Manager Airstream, Inc.
Jackson Center, Ohio 45334
(513) 596-6129

WALLY BYAM CARAVANS AND CARAVAN CLUBS

You are now an Airstream owner. The magic doors to fun, friendship and adventure are wide open to you . . . and the rich rewards are endless. You are now eligible to take part in all Wally Byam Caravans and Airstream Rallies. There are two rallies held annually: one in the West and one in the East, and folks look forward to them with eager anticipation year after year.

As an Airstream owner, you are also eligible to make application for membership into the Wally Byam Caravan Club, the largest and most influential travel trailer club in the world. There are WBCC units throughout the United States and Canada. All operate autonomously, electing their own officers and setting their own dues. All new members are required to join through a local unit. (Legislation was adopted in 1962 stating that members-at-large would no longer be accepted.) At the time your application is made, International dues are paid along with Unit dues. At present, International dues are \$3.00 per year per trailer. Unit dues average from \$1.00 to \$5.00.

Some units get together for monthly Rallies while some have weekly Dutch-treat dinners in addition to their regular Rallies. In areas where weather does not permit year-round Rallies, the dinner meetings are very popular. They give members a wonderful opportunity to keep in touch and to plan Rallies for the more seasonable times of the year. International, Regional, and Unit Officers are elected annually.

If you are interested in joining the Wally Byam Caravan Club, get in touch with the secretary in your area. The name of each secretary is listed in the Headquarters Office (822 Niles Street, Bakersfield, California) and your letter will be forwarded.

The first Wally Byam Caravan was in 1951. Since then there have been 44 Caravans to most parts of the world. The annual Caravans to Canada and Mexico have become so popular that in recent years we have conducted two Caravans each year to these neighboring countries.

Traveling with a Wally Byam Caravan teaches you how to travel in a foreign country as well as how to get the most enjoyment out of your Airstream. You travel with both old and new Airstream owners; sharing experiences, learning from one another and enjoying a new kind of fellowship. On the Caravans and in the Club, you will make life-long friends — friends who become closer and dearer to you than many you have known all your life. As Wally used to say: "You will never be alone or lonely."

Traveling with the Caravan offers many advantages; the security of group travel, recognition, and unusual opportunities to see special places and meet special people. Many of these opportunities, which would never be possible for individuals, are routine for the Caravan. The blue beret, the badge of Airstream ownership and identification for a Wally Byam Caravanner and Club member, is an open sesame to excitement and adventure.

Several months before a Caravan rolls, it is announced in the CARAVANNER, our monthly publication. A registration coupon is printed for your convenience, and everyone who registers receives a detailed bulletin telling about that particular Caravan, what to bring along, and how to prepare for it. When going to Mexico and Central America, such matters as insurance, tourist cards and other details connected with border crossings are all handled for you by the Headquarters Office. When you go on a high adventure Caravan, such as one to Europe, Africa, or around the world, all details are also taken care of for you. About all you have to do is get your passport and take your shots. Those are two items we can't do for you — or we would!

On every Wally Byam Caravan, the route is carefully planned and arrangements are made for parking, entertainment, tours, etc., long before the Caravan ever leaves. A day-by-day itinerary is planned and a copy indicating the mail stops is given to all Caravanners in advance.

Although Airstream provides a Caravan team consisting of a leader, recreation director, scout, and service representative, the Caravan is actually run by committees made up of the Caravan members themselves. The Wally Byam Caravans are a family affair. Everyone participates and becomes a part of the great Airstream family. Each is an unforgettable experience.

Only Wally Byam Caravanners and WBCC members are entitled to the official Caravan numbers, and to be listed in the annual directory. Club members receive their number from the Headquarters Office. The Caravanners who are not Club members receive their numbers at the rendezvous point before the Caravan leaves.

The annual directory lists all WBCC members and Wally Byam Caravanners including names of those

who have parking space available at home for fellow Airstream owners. It's really wonderful to be able to pull into the yard of a friend (even if you have never met) rather than have to hunt for a trailer park. The directory also lists a schedule of all major rallies for the year, all WBCC officers, those with Citizen Band radios, the WBCC Amateur Radio Club (hams) and a list of Wally Byam Caravans.

Since 1958 there have been annual WBCC International Rallies held toward the end of June and the first week of July every year. Wally's birthday was July 4, and the first Rally was in the form of a huge birthday party for him, patterned after the international Rallies in Europe which he loved to attend. Until 1956, when the first Wally Byam Caravan attended the rally in Perpignon, France, Wally and Stella had been the only Americans present. Everyone had such a good time at this first big get-together held in the beautiful Ozarks that the club decided to make it an annual affair. Since then International Rallies have grown tremendously in size and scope. The 1964 International Rally near Princeton, N.J. brought together more than 2000 Airstreams and some 7000 happy people. The site of the International Rally for the summer is announced in an early fall issue of the CARAVANNER.

In all our Caravan and Club activities, the program is planned for all ages — from babes in arms to those in their nineties — but you would never guess that anyone was in that 90-year bracket.

Within the WBCC are square dance clubs, past presidents clubs, Citizen Band radio clubs, the ARCs (hams), special study groups, hiking and bird-watching groups, avid fishermen and boating enthusiasts.

Along with the fun, our Airstream owners recognize the need for better legislation regarding travel trailers; more overnight parking places, more sanitary stations for emptying waste-holding tanks, etc. They're also quite alert to bills adverse to travel trailers. In this field, the WBCC has a strong National Legislative Committee, and we are justly proud of their accomplishments.

When you bought your Airstream, you not only bought the prestige travel trailer in America, but truly a whole new way of life. Enjoy it! Many new friends are waiting to be made . . . new interests are waiting to be found . . . new adventures are waiting to be discovered. We're happy to welcome you into our Airstream family.

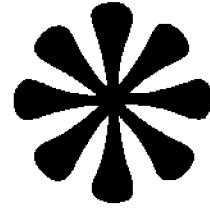

**TRAILERING
IN YOUR
AIRSTREAM**

CHAPTER 1

GETTING ACQUAINTED WITH YOUR AIRSTREAM

The first thing you should do in order to get the most carefree fun from your Airstream is to get to know it thoroughly. Figures 1-A and 1-B show a 26-foot International model. Regardless of the particular model or size of your Airstream, most of the details shown on the photographs apply.

feature gives quick access to "hook-up" and service the self-contained utilities in your trailer. Details on each utility follow in Chapters 6 through 13.

There are as many accessories and appliances for your Airstream as there are for any home. Your Airstream dealer will be able to help you select those accessories you will need, depending on where you wish to travel and for how long.

Figure 1-C shows the "One-Stop Service Center." This

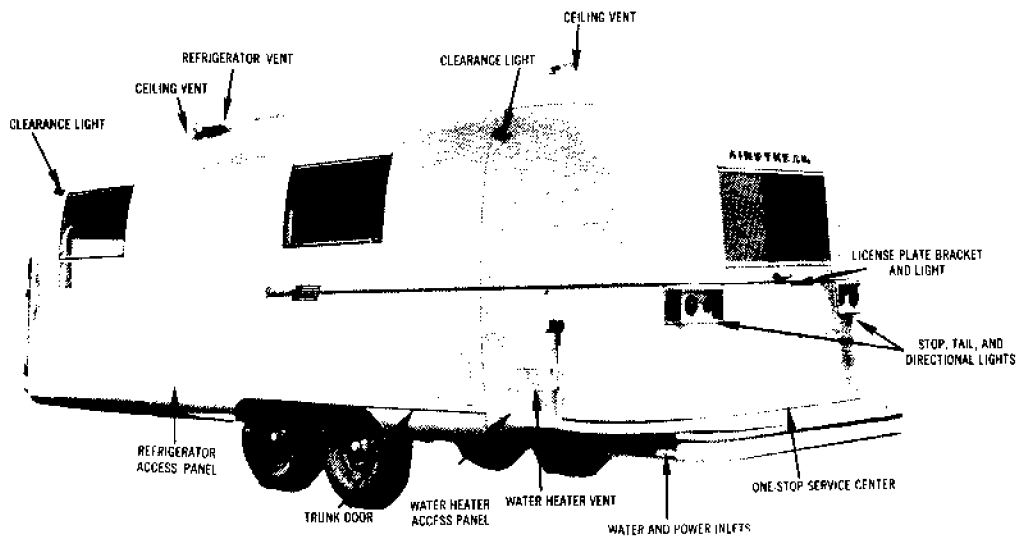
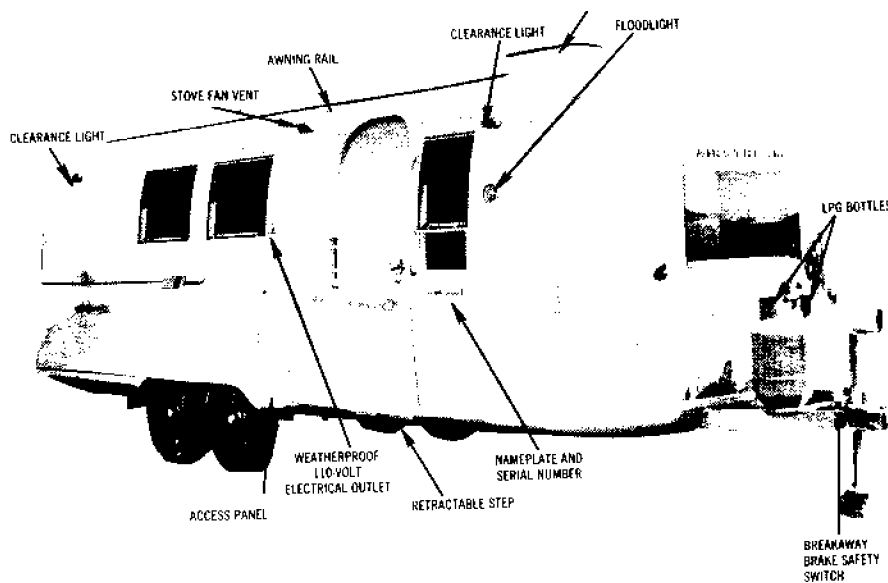

FIGURE 1-A

FIGURE 1-B



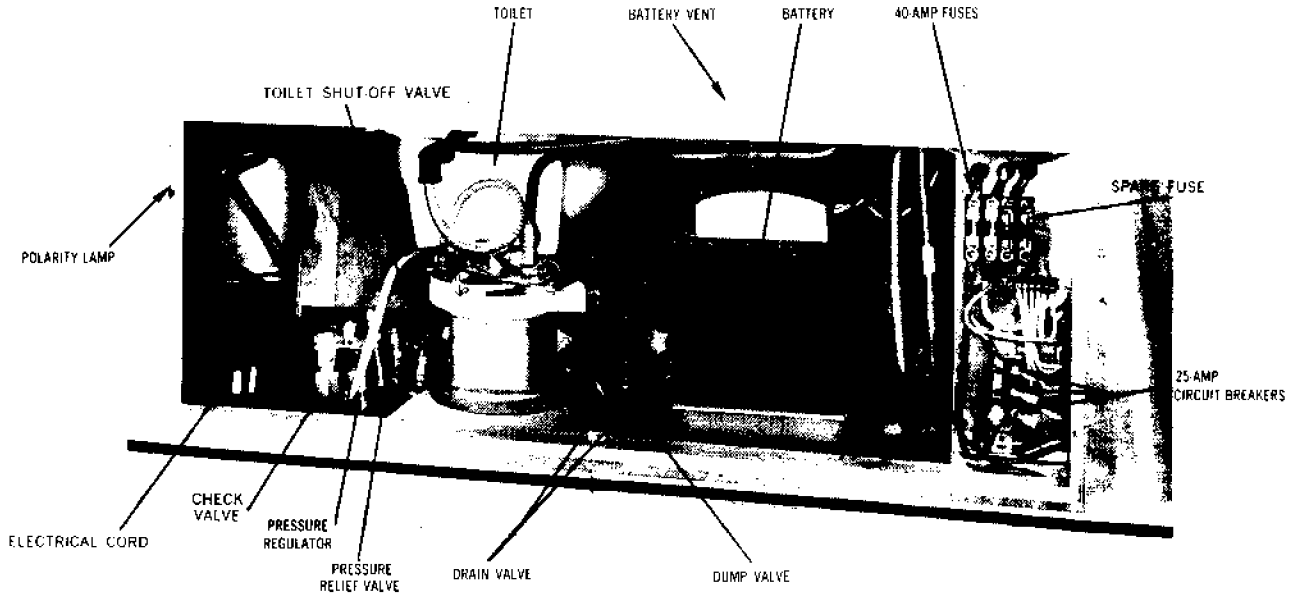

FIGURE 1-C

RADIO AND TELEVISION

Since the aircraft-type aluminum construction of your Airstream makes an almost perfect radio "shield" you will need outside antennas for good reception of either radio or television.

Your new Airstream is wired for an exterior television antenna. To install the antenna it is recommended that you go to your Airstream dealer since it must be structurally mounted to the outside skin. The lead wires will be found curled inside the wall of the trailer on the door side of the front window. The exterior antenna should be mounted to the side of the window so that the leads can be connected at that point. The other end of the leads will be found hanging behind the electrical panel behind the refrigerator. This has been located in the most convenient spot for TV viewing in your particular model. Your dealer will recom-

mend the best folding type TV antenna for your trailer or see any Wally Byam Store.

A police-type telescoping whip radio antenna is recommended particularly for 12-volt transistor AM-FM radio use. This should be installed on the front of your trailer on a swivel ball mount.

AIR CONDITIONING

The Airstream Bay Breeze air conditioner is specially designed to keep your trailer cool and comfortable in the hottest weather. Since the Bay Breeze requires certain modifications in your trailer, it should only be installed by one of the many Airstream dealers who are equipped for this type of service or at one of the two Airstream factories.

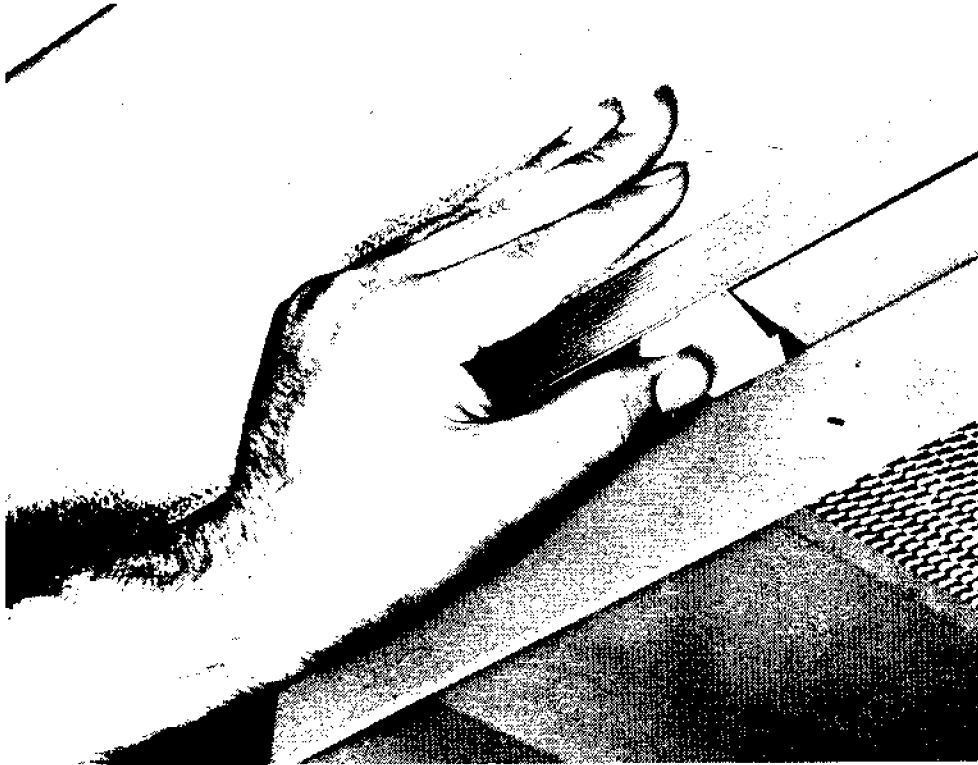

FIGURE 1-D

A FEW ADDITIONAL ITEMS

1. All drawers and shelves in storage areas are removable, allowing you greater flexibility in arranging the storage of your possessions to your own particular liking.
2. Roof lockers are equipped with hidden catches, and continuous hinges on the doors. To open the locker, squeeze the latch; to close, just shut the door firmly—the latch will engage by itself. (See Figure 1-D).
3. Your screen door screen is made of plastic for longer wear and ease of maintenance. It can be easily cleaned with a damp cloth, and of course it can not rust. However—while it will not burn—contact with fire, such as a lighted cigarette, will cause it to melt at the point of such contact.

CHAPTER 2

GETTING READY FOR THE ROAD

YOUR CAR

Since your Airstream is designed and built for easy towing, almost any car has enough power and weight to tow it under level, dry conditions. However, experience has proved that a heavier car is advisable for towing the larger units (26-foot and up) under difficult weather conditions and on hills. A heavier car will also help you maintain complete control on slippery downgrades.

WEIGHT-TO-HORSEPOWER RATIO

From the experience of thousands of trailer travellers, Airstream engineers have developed a "weight-to-horsepower" ratio to serve as a guide for matching tow cars to Airstreams. To obtain this ratio, add the weight of the trailer to the advertised weight of the automobile and divide by the advertised horsepower of the automobile.

Example: To determine the weight-to-horsepower ratio for a 250 horsepower Ford sedan weighing 3829 pounds and a 26-foot Airstream weighing 3950 pounds, the formula would read:

$$\frac{3950 + 3829}{250} = 31.12 \text{ pounds per horsepower}$$

Experience has shown that the practical upper limit for most road conditions is 60 pounds per horsepower. Anything in the range of 30-40 pounds per horsepower is very adequately powered with any lower ratio being a "hot rod."

Another guide for matching the tow car to your Airstream is to have the car and trailer weights nearly the same. Your Airstream will tow easier if it is not markedly heavier than the tow car. Of course, if your car is heavier than the Airstream so much the better.

The auto transmission can be manual or automatic as you prefer. Automatic transmissions are recommended by the automobile manufacturers because they do a better job of controlling engine loads than the average driver can with a manual shift. The automatic will prolong your car's engine life.

The hitch is an all-important item. Your dealer will advise you on the best make for your particular car, but in all cases be certain that a frame-mounted hitch is used. A leveling type hitch (there are several makes on the market) allows the weight of the trailer hitch

to be evenly distributed over all four wheels of the car. It provides, in addition, a certain amount of anti-sway protection. Installation of the hitch is crucial and should be attempted only by a competent man who is thoroughly familiar with structural welding. Your dealer should either make the installation for you, or will supervise and inspect it. When installed, the top of the hitch ball should be approximately 20½" from the ground (19" for the Caravel) with the car level and not attached to the trailer. If this dimension is maintained, the car and trailer will be level. Make certain the attaching points for the safety chain and the break-away switch are on the portion of the hitch that is welded to the car, and not on the removable ball mount.

THE ELECTRICAL CONNECTIONS

A seven-conductor auto cord wiring system is used to connect your Airstream to your car. Through a single, locking, polarized connector your trailer battery will be charged, its brakes will be operated and the running and signal lights will be activated simultaneously with those on your car. Figure 2-A is a diagram of the connector used on your trailer.

Your Airstream is equipped with Kelsey-Hayes two-shoe adjustable brakes . . . the finest trailer brakes available. To insure proper operation your car should be equipped with a genuine Kelsey-Hayes controller and resistor. Your Airstream dealer will either make the installation, or supervise and road test it for you. If you have any other controller already on your car, have it removed, and have the Kelsey-Hayes controller which came with your Airstream installed.

ACCESSORIES FOR YOUR CAR

A truck or trailer type rear view mirror is required by law in most states. This is to allow you to see out past the trailer. Several good makes are available from your dealer. A right-side rear view mirror is also highly recommended.

If your car has an automatic transmission and you intend to travel through mountainous country, you may wish to have a transmission oil radiator such as the Hayden Trans-Cooler installed to help your engine and transmission to run cooler and prevent possible damage. This is available through your Airstream dealer.

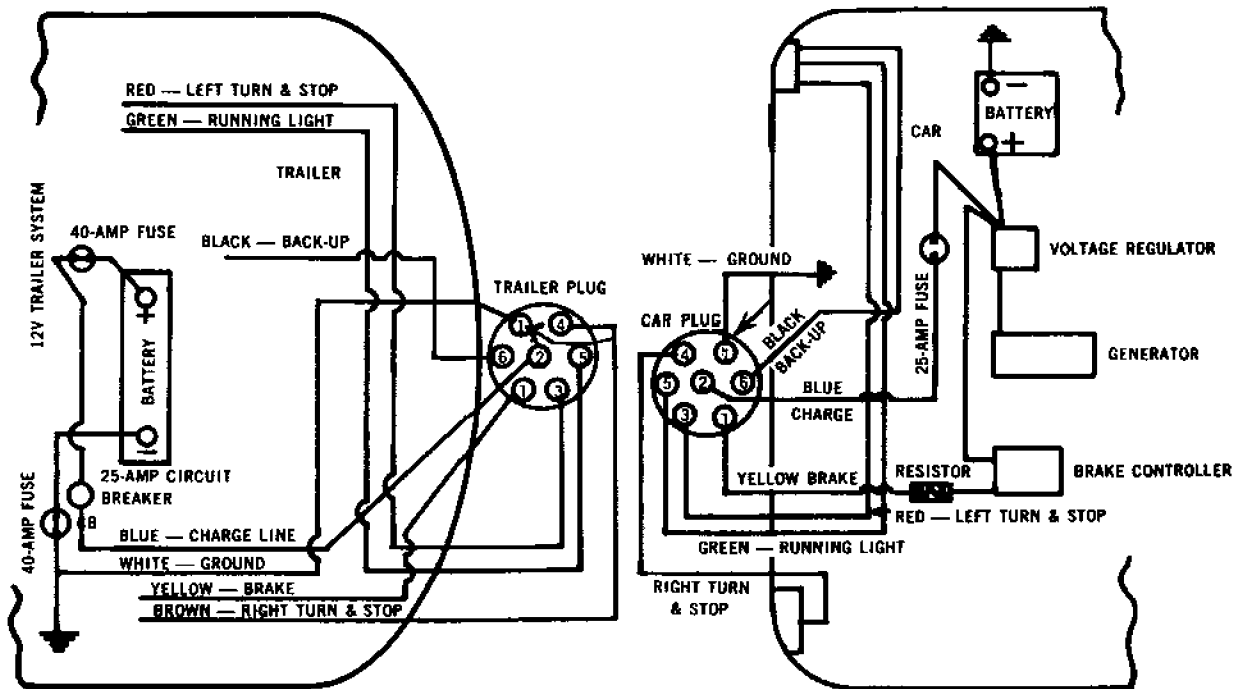

NOTE: Polarity of trailer battery must match polarity of car battery; e.g., if negative pole of car battery is grounded, negative pole of trailer battery must be grounded.

Spare 40-amp fuses should be carried (available at larger auto supply or truck parts stores)

FIGURE 2-A

OUTFITTING YOUR TRAILER

Outfitting your Airstream, that is converting the bare vehicle you bought from the dealer into a comfortable home, is very similar to outfitting any home or apartment. Your Airstream is completely furnished, but there are many little personal touches you will want to add. Since your Airstream will be subject to the vibration and bumps of the road, anything that is attached should be done so firmly. A small hand drill should be used to drill holes in the aluminum inner walls and one-half inch No. 8 sheet metal screws, with flat binder heads, used to attach such things as hooks for clothing, book shelves, extra towel racks... those little accessories you "can't do without." Note: Always check polarity light after drilling through skin to make certain you have not drilled into a wire and caused a short.

EQUIPMENT YOU SHOULD CARRY

1. A first aid kit.
2. A tool box with an assortment of small hand tools such as screw drivers, hammer, pliers, wrenches, etc.
3. A tow rope. $\frac{3}{4}$ " to 1" nylon is sufficient. At least 35 feet is recommended.
4. A lug wrench to fit your trailer wheel lugs.
5. A hydraulic jack for your trailer axle.
6. A set of stabilizing jacks.
7. A spare tire for your trailer.
8. A fire extinguisher.
9. Plastic buckets for carrying water (at least two).
10. Wheel blocks. These should be 4 blocks of wood approximately 7" square and 4" thick, slanted at one end to fit against the tire, to block the wheels when parked.
11. A hundred feet of $\frac{5}{8}$ " water hose. (A "Y" connection is useful when you travel with others since it permits two trailers to be hooked together on one faucet.
12. 1 short (4 ft.) and 1 long (10 ft.) sewer hose and a coupler.
13. A 75-foot 3-wire electric cord with a 30-amp capacity, with grounding-type 3-prong plug and receptacle.
14. A small spirit level (two will be helpful).
15. A flashlight.
16. A short handle shovel (the Army surplus G.I. type is satisfactory).

17. A pick or pry bar.
18. An axe.
19. A five gallon gasoline can.
20. A large funnel.
21. A folding chair for each person.
22. Cleaning equipment: broom, dust pan, mop bucket, mop, sponges, etc.
23. Road emergency flares.
24. Spare cartridge-type 40-amp fuses.

In addition to the above, you will find many other accessories to make your trailering more enjoyable, available at Wally Byam Stores and your trailer dealer. As you travel you will develop your outfit to suit your particular trailering needs.

LOADING YOUR AIRSTREAM

When you took delivery of your Airstream, you received a trailer that was the result of millions of miles of road testing and towing in every clime and terrain. The center of gravity and the weight placed on your car's hitch has been precisely calculated to provide the easiest possible towing. You can maintain this easy-towing trim by following two basic rules.

1. Keep your trailer as light as possible.
2. Distribute the weight as evenly as possible.

The amount of baggage and personal gear that you take is determined by how you like to travel and where you will be traveling. However, every item that you take along is one more thing that you will have to stow before going on the road and will add just that much more weight which your car must pull. Regardless of what weight of personal belongings you take with you, always make certain that you maintain the perfect balance that has been built-in your Airstream. The loaded Airstream should have 12% to 15% of its total weight on the trailer hitch. A tongue that

is too light can cause the front end to float and the trailer to weave at higher speeds. When it is too heavy it may prove too much for your car.

Your Airstream is designed with storage space arranged in such a way that if ordinary things are put in ordinary places the weight will come out about right. If you are carrying heavier items, place them near, or just forward of, the wheels. Stow everything as low as possible to maintain your low center of gravity. Keep fragile things well forward of the axle as the front of the trailer is stabilized by the hitch, while the back will tend to bounce more.

Secure loose items left out in the open to prevent them from sliding around while you are towing your Airstream. Stack loose material such as chairs on the floor. Lash down smaller objects that are not put into a cabinet. Place heavy loose items such as cans in drawers near the floor.

The extra care that you take while you are loading your trailer will pay off in reduced strain on your car's engine and springs. This may not be too important on super highways, but a few hundred miles of rutty country road will prove the wisdom of loading your trailer properly. As you become a more experienced trailer traveler, you will undoubtedly pick up tricks such as using aircraft shock cord to lash down radios and other objects that you don't want to put in cabinets; placing hooks in strategic places so that the shock cord can be quickly attached. When packing your cupboards remember that a partially empty cupboard will permit the contents to move about and become damaged; it is better to have one full roof locker and one empty one than two which are half-filled.

Never carry pierced containers of liquid in the refrigerator; always make certain that all containers are tightly sealed. Liquids such as milk and juices should always be transferred to plastic containers with tight fitting caps. If you must carry paper cartons, place a sheet of heavy cardboard between the carton and the wire shelf to prevent the wires from wearing through the carton.

You are now ready for travel adventure.

CHAPTER 3
TOWING YOUR AIRSTREAM

HITCHING UP

Hitching your Airstream to your car is something that will become almost second nature to you. You will develop your own technique with practice but there are a few tips, learned from experience, which will help you. The first thing to do is to jack up the trailer tongue until there is clearance for the hitch ball to slide under. Raise the locking lever on the hitch. The car now should be backed, straight back, to the hitch connection. This can be made easier by placing a strip of tape on the rear window of your car and another on the front window of your trailer. By sighting over these two strips of tape you will be able to line up the hitch with the hitch ball closely enough to make the hook-up by yourself. Of course, the job is much easier if you have the help of another person and use pre-arranged hand signals.

When you have lined up the ball under the hitch, screw the trailer jack down until the full weight of the trailer is on the ball. Drop the locking lever and place the safety bolt in the hole to prevent the lever from being accidentally lifted.

If you have a leveling type hitch on your car *jack up* the trailer to the full height of the iack before pulling up the leveling bars. A little practice with your hitch will teach you how far to pull up the leveling bars to get the car and trailer level. *Always do this on level ground.*

Plug in the electrical light and brake connector. Check running, directional and stop lights.

Attach breakaway brake cable to car. Attach safety

FIGURE 3-A

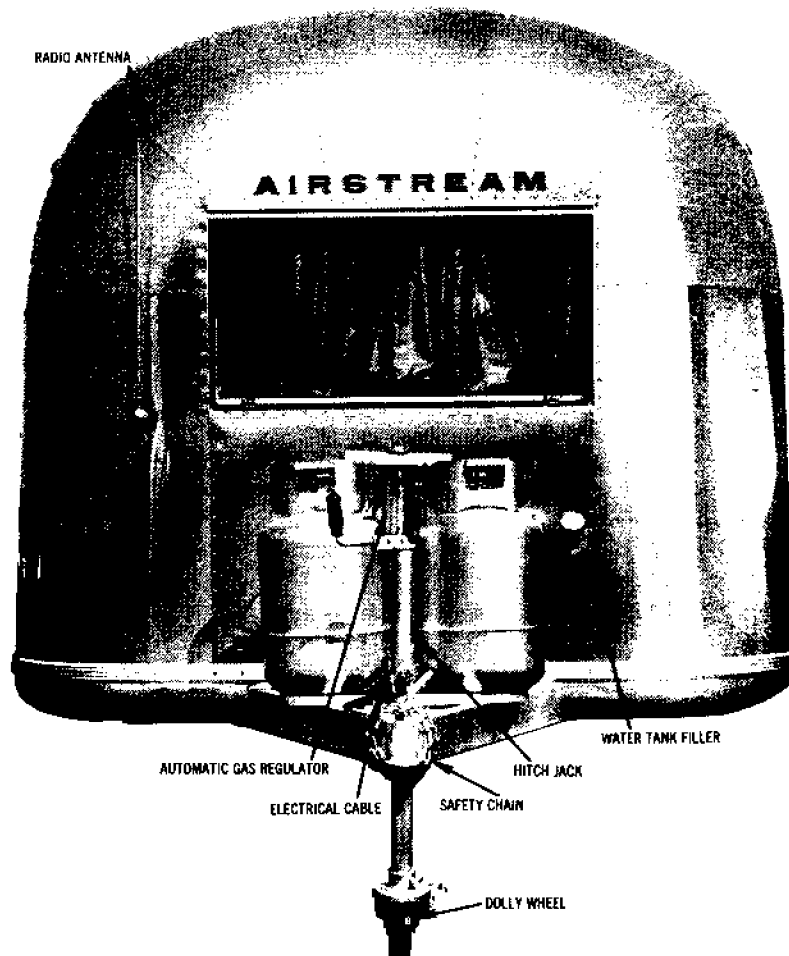

chain to car. Note: In many states it is illegal to attach the safety chain to the hitch in front of the ball and for good reason. If there ever is an accident, the most logical failure would be at the ball. Always attach the safety chain to your car's frame or to the hitch at some other point.

Retract the hitch jack to its full height for maximum ground clearance. Remove the dolly wheel and stow it in your car's trunk or some other safe place. *Never tow your trailer with the jack down and the dolly wheel on.* The dolly wheel is not designed to be left on the jack and may fall off and become lost during travel.

Move the car ahead slowly and test the trailer brakes. Have someone verify the operation of your trailer's running and stop lights.

BACKING YOUR AIRSTREAM

Backing your Airstream is really quite simple. The important thing to remember is to do everything slowly and to correct immediately if the trailer starts turning in the wrong direction.

Concentrate on the rear of your trailer. The first thing to do is to aim it in the direction in which you wish to back.

Grasp the steering wheel of your car at the bottom and while backing as slowly as possible turn the wheel in the direction you want the rear of your trailer to go (see figure 3-B). Watch, either in your side rear view mirror or by sticking your head out the window, until the rear of your trailer is pointing in the right direction. Next, while backing slowly, turn the steering wheel slowly in the opposite direction. Your car is now following the trailer in an arc (figure 3-C). If the trailer starts to jackknife or is not turning quickly enough, slowly correct the direction with the steering wheel or stop completely, pull forward a few feet and start again. When you want to change directions while backing turn your front wheels more sharply (figure 3-D). As soon as the rear of the trailer has turned in the right direction slowly turn the steering wheel in the opposite direction (figure 3-E) and follow the rear of your trailer around the new arc (figure 3-F). To go straight back pull the trailer forward until car and trailer are in a straight line. Put the car in reverse and back slowly making small corrections with the steering wheel as necessary to keep in the straight line (figure 3-G). If the trailer gets out of line, stop, move forward a few feet and start over again.

A few hours practice in a large parking lot or on a deserted road will make you an expert in backing your Airstream.

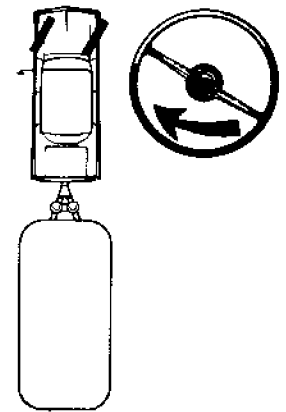

FIGURE 3-B

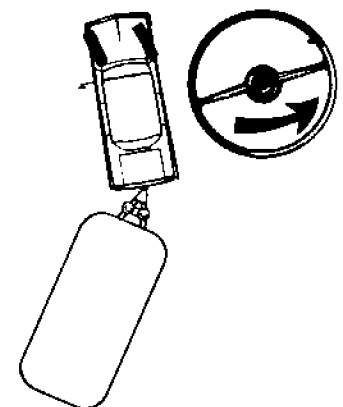
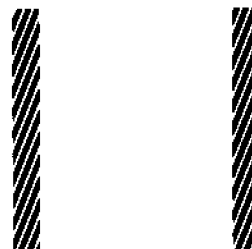
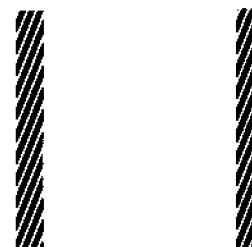

FIGURE 3-C



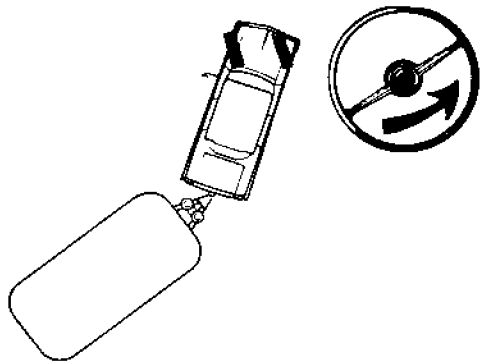

FIGURE 3-D

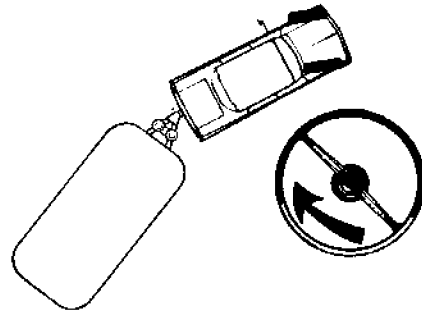

FIGURE 3-F

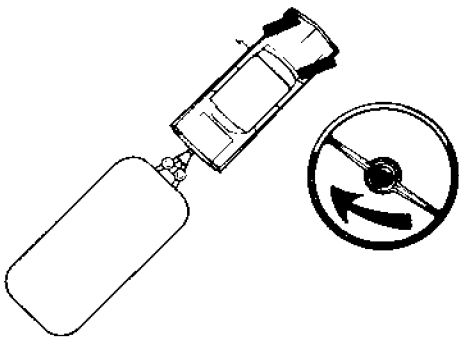

FIGURE 3-E

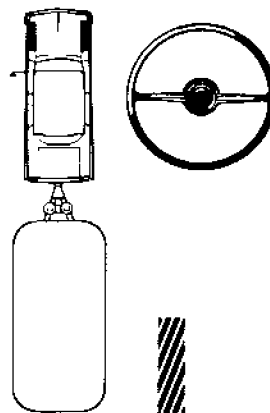

FIGURE 3-G

TIPS ON TOWING YOUR AIRSTREAM

Before you start out, always make it a practice to go through the following check-list:

1. Disconnect and stow the electrical hook-up cord.
2. Disconnect and stow sewer hook-up hose.
3. Disconnect and stow water hook-up hose.
4. Turn off gas line shut-off valve (under top of range).
5. Check clearance, tail and stop lights.
6. Remove and stow leveling jacks and wheel chocks.
7. Check hitch to make certain it is properly attached by cranking down the hitch jack until the rear bumper of the car is raised about 6 inches above normal.
8. Raise jack to full height, remove and stow dolly wheel.
9. Close windows and vents. Lock door.
10. Pull up the step.

Experienced trailer travelers make it a habit to move their rig ahead about 50 feet, stop, get out and walk back and check the ground where the trailer has been standing. This practice can save you countless dollars and annoyances from lost tools and other gear.

The key to towing any trailer is to do it smoothly. Starting and stopping slowly and smoothly saves gas, wear on your car and prevents damage to the gear stowed in your trailer. Your Airstream is designed to be towed at any legal speed that is safe for your car alone and you will find that your Airstream tows and follows your car so effortlessly you may soon forget it is behind you. Never permit yourself to do this. When you are towing the trailer you should always maintain an interval with the car in front of you of at least a car and trailer length for every 10 miles per hour of speed. This gives you ample time to stop in the event of an emergency and permits drivers behind you to pass and get back into your lane safely. Remember, when you pass another vehicle that you will require a little longer than usual to accelerate and that you must allow for the length of the trailer when returning to your lane. Try to pick the lane in which you want to travel and stay in it.

You will substantially increase your gas mileage if you can avoid unnecessary starting and stopping. Before you come to stop signals, slow down and time it so that you will not have to stop completely. Take a tip from professional drivers when rounding turns; instead

of staying at full speed and then putting on the brakes, slow down well in advance of the turn, enter it at reduced speed, then accelerate smoothly as you come out again onto the straight-away.

When going up a long grade, shift into a lower gear well in advance of when your engine labors. When going down a hill, use a lower gear, or a lower range if you have an automatic transmission, so that the compression of the car engine will help slow your whole rig.

When you are stopping on slippery pavement however, never use engine drag to help you slow down because the drag on the rear wheels may cause skidding and jackknifing. When stopping on slippery pavement, using your trailer brakes slightly in advance of your car's brakes will prevent any tendency to skid and jackknife. Chains don't do any good on trailers. When driving on icy roads take it slowly and if it feels that the car is skidding, gently apply the trailer brakes to keep the trailer and the car in a straight line.

When stopping on dry and normal pavement, applying your Airstream brakes simultaneously with your car's brakes will stop your entire rig in approximately the same distance that your car's brakes will stop your car alone. When stopping on a hill or slight grade, if leaving the car in gear is not sufficient to keep the outfit at a standstill safely, chock the wheels with a block of wood. Whenever you park your Airstream on a hill or slight grade and disconnect the car *always* block the wheels.

One of the hardest things on any trailer is the "thank you ma'am" — the sharp dip or depression in the highway such as you may encounter on cross streets where gutters continue through the intersection. This straight up-and-down thrust can very easily damage any item left loose in your trailer. Take dips and depressions slow and easy and be certain that the trailer as well as the car has passed them before resuming normal speed. If the rear end of the trailer drags bottom, it won't do any damage if you are traveling slowly.

To prevent overheating when driving in the mountains never let your car labor. Shift to a lower gear, or range if you have an automatic transmission, before it becomes absolutely necessary. Your car's ability to pull without becoming overheated is a function of the engine, your car's cooling system, the transmission, the weight of your trailer when loaded and the type of terrain over which you are traveling. A little practice will teach you your car's limits and it will pay you in time and money to stay within them to prevent the

heat damage to the engine and transmission.

When traveling through sand or mud always keep rolling; let your momentum carry the tow car and trailer through. Don't depend too much on the drive wheels. Stay in the rut of the car ahead, if possible, and keep your car in the highest possible gear. The easiest way to get a stuck outfit out of the sand or mud is by towing it out. Carry a length of rope or chain to attach to a passing car or truck for this purpose.

If you tow long distances over unimproved roads, the stones and gravel picked up by your tires and thrown back can dent and scratch the beautiful aluminum finish of your Airstream. To prevent this, experienced trailer travelers use masking tape to secure heavy sheets of paper or plastic onto the lower front of their trailers.

Get into the habit of regularly checking the lug nuts

on your tires and the tire pressure. Traveling over bumpy, rough roads can loosen lug nuts and if the wheel should come off it could cause severe damage to your Airstream. Experienced trailer travelers always check the condition of their tires, the tightness of the lug nuts and the tire pressure before "hitting the road."

SECURING THE MAIN DOOR

It is very important that the main door of your trailer be completely closed during towing. If it is not properly secured, the constant vibration of travel can cause it to fly open and possibly break.

To lock your door for towing, turn the deadbolt clockwise as far as it will go: **the knob will be in line with the punched mark on the surface of the deadbolt plate.** CAUTION: The door latch also acts as a deadbolt when it is locked. **DO NOT slam the door with either the door latch locked or the deadbolt in the locked position.**

STOPPING FOR THE NIGHT

When you bought your Airstream you freed yourself from the tyranny of the timetable and the necessity of making reservations wherever you go. There is no end to the number and variety of interesting and convenient places where you can park your Airstream overnight, or for several days. Your Airstream is built to be safely parked on practically any spot that is relatively level and where the ground is firm. You have everything with you, self-contained, that you could ask for. Airstream owners have parked virtually every place imaginable from filling stations, to farm lands, in driveways, etc. In time you will develop a knack for spotting wonderful little roadside locations by turning off the main highway and exploring.

The North American continent is generously dotted with thousands of modern, private trailer parks that have special facilities for trailers. These generally offer considerable privacy and easy utility hook-up facilities for electricity, water and sewage . . . all at modest rates. You will find many Federal, State and Civic trailer parks that are clean, inexpensive and are located in beautifully wooded areas with convenient access to utilities.

On overnight or weekend trips the chances are that you will not use up the capacity of your sewage holding tank, deplete your water supply or rundown the battery which supplies your 12-volt current. On a longer trip, when you have stayed where sewer connections and utility hook-ups are not available, it will be necessary for you to stop from time to time to dispose of the waste in your holding tank and replenish your water supply. Many gas stations (chains and individually owned) have installed sanitary dumping stations for just this purpose.

Many trailer travelers who prefer to make their overnight stops "off the beaten path" make it a practice to stop at trailer parks every few days to replenish their water supply and dump the waste from their holding tank. (Refer to Chapter 13 in Section II for details on the operation of the waste holding tank).

In stopping for the night, unless the car is needed for

transportation, it is not necessary to unhitch. The trailer should be somewhere near level for comfort, and closer than that for good gas refrigeration during a longer stay.

Try to pick as level a parking spot as possible. Stabilizing jacks or blocks probably won't be required for an overnight stay; putting the jack pad on the hitch jack and running the hitch jack down to take the weight off the car's springs should provide enough stability. If you must park on a slope, park down-hill; it is easier to level and stabilize the Airstream this way.

All you need to do to enjoy the self-contained luxury of your Airstream is to:

1. Light the water heater, refrigerator and furnace pilots if required.
2. Turn on the gas supply at the stove and light the stove and oven pilots (oven only on 26-, 28-, and 30-foot models).
3. In the 17' Caravel — throw both switches in the trunk compartment to the "Battery Power" position.

Before moving on be sure to check your campsite, both for cleanliness and to be sure you haven't left anything behind; turn off the gas supply pet cock to the stove; make sure everything is properly stowed, your hitch is tight, your electrical connection is made, you are ready for travel adventure!

Note! Several directories of trailer parks are available. Check your dealer for his recommendations. These include:

- a. Woodall's Mobile Home and Travel Trailer Park Directory (Woodall Publishing Co., 740 N. Rush St., Chicago 6, Illinois) \$2.
- b. Travel Trailer Park Guide (Mobile Home Manufacturers Association, 20 N. Wacker Drive, Chicago 6, Illinois) \$1.
- c. California Mobilehome Park Directory (Western Mobilehome Association, 5768 Pico Blvd., Los Angeles 19, Calif.) \$1.
- d. Florida Trailerite Handbook (Trailer News Publishing Co., Coral Gables, Florida) \$.60.

PREPARING FOR AN EXTENDED STAY

Making a long trip in your Airstream is not very different from making a week-end excursion. Since everything you need is right at hand you are at home wherever you go. When packing for an extended trip take everything you need, but *only what you need*. Follow the tips in Chapter 2 on stowing your belongings.

When you plan to stay in the same place for several days, weeks or months, you will want your trailer to be as level and as steady as possible.

LEVELING

For comfort and for good refrigeration, it is very important to have your trailer as level as possible. To get it level use small spirit levels located as follows:

Two on the tongue; one in front and one in back; and one near the door (either mounted over the door or on the floor. Or . . . Two placed at a 90° right angle to each other, on the trailer floor.

Don't expect to get all bubbles in the exact center, just try to get close.

To level front-to-back:

Disconnect hitch, put jack pad on jack and screw down until you are level.

To level side-to-side:

Run the wheels on the low side up a small ramp consisting of a wedge about 3 feet long, tapered from 1" to 4-5".

Block the Wheels.

Use blocks or stabilizing jacks at all four corners to

eliminate the natural spring action of the axles and give you a stable floor.

Note: When using stabilizing jacks never put a great deal of pressure on them when they are placed on the rear bumper of the trailer. Whenever the trailer must be lifted with a jack, as when changing a tire or leveling on very rough terrain, always place the jack under the main frame member which is located 15" inboard from the outside edge of the trailer and 4" to the rear of the wheel well. Lifting the trailer by the bumper may cause "canning" of the roof or back end sheets.

Remove the cap from the water and power entry fitting. Hook up to the water by attaching a 3/4" water hose to the city water service. (See Chapter 12 for details on operation of the water system.)

Plug the electrical cable, located in the same compartment, into the city power service. Be sure you have the wire grounded and have the proper polarity (See Chapter 11 for proper procedure).

Hook your waste drain hose into the sewer disposal facility and attach to the drain outlet in your trailer by removing the drain cap, pushing hose on and twisting until it feels secure. Open holding tank dump valve; drain and flush tank; close valve. (See Chapter 13 for details on operation of sewage system).

Turn on the gas petcock under the top of the stove; light the stove and oven pilots (oven only on 26-, 28-, and 30-foot models). Light the water heater, refrigerator, and furnace pilots. (See Chapters 6 through 10 for operation of the LPG system and appliances.)

Enjoy the good life!

SECTION II

**THE SELF-CONTAINED UTILITIES
IN YOUR AIRSTREAM**

There are four complete utilities systems built into your Airstream: Gas; Electricity; Water; and Sewage. These utilities permit you to cast loose the bonds of civilization and travel where you wish without sacrificing any comforts.

The next eight chapters of this Manual are devoted to instructions for operation and maintenance of the utility systems in your Airstream. If you require specialized service contact your Airstream dealer, the nearest Airstream factory or one of the factory service depots listed under the chapter on the individual appliance.

CHAPTER 6
**THE LPG (LIQUID PETROLEUM GAS)
SYSTEM**

The LPG system in your Airstream is illustrated on the reverse side of this page.

Your Airstream is equipped with two bottles for LPG (Liquid Petroleum Gas). LPG burns with a clean blue flame and produces much more heat than natural gas. There are two basic types of LPG in common usage: Butane and Propane. Butane is widely used where temperatures are normally above freezing the year around and Propane is used where sub-freezing temperatures are common, since Butane freezes at 32°F as compared to 0°F for Propane. All of the orifices in your Airstream LPG appliances are of the universal type which will burn either fuel.

How long a full bottle of gas will last is of course dependent on usage. In cold weather when you are using the furnace extensively; large amounts of hot water; and are doing extensive cooking, you will naturally use more than you will in warm weather and when you do limited cooking. On the average, with normal cooking and other appliance use, you can probably count on three weeks service from each full 28-lb. bottle or two weeks from each 20-lb. bottle.

International models are equipped with an Automatic Gas Regulator. Both tanks are connected to the A.G.R. and are turned on. Gas is drawn from only one bottle at a time and when the bottle being

used is depleted the A.G.R. automatically switches to the full tank. An indicator on the A.C.R. points toward the tank being used to give you a visual reminder when one tank is empty. The empty tank can be removed for refilling without disturbing the tank being used. Simply disconnect it, have it filled and re-connect. When the tank being used is emptied, the A.G.R. will automatically switch over, provided the other tank valve is also open.

Turn on gas petcock under top of stove; light stove and oven pilots. Light water heater, refrigerator and furnace pilots (if out). See Chapters 6-10 for operation of LPG system and appliances.

Enjoy the good life!

To remove the gas bottle, disconnect the tubing nut with a wrench and loosen the large wing nut which holds the bottle in place. The tubing nut has a *left hand thread* so be sure to always turn it *clockwise* to loosen and counter-clockwise to tighten. When replacing bottles, connect and tighten bottles before clamping them in place.

If you have allowed both bottles to run out, air may have gotten into the lines. In this event the air must be forced out through the lines by the gas pressure before you will be able to light your pilots. Hold a match to the pilot of the appliance closest to the tanks until it lights. Then move to the next closest, etc.

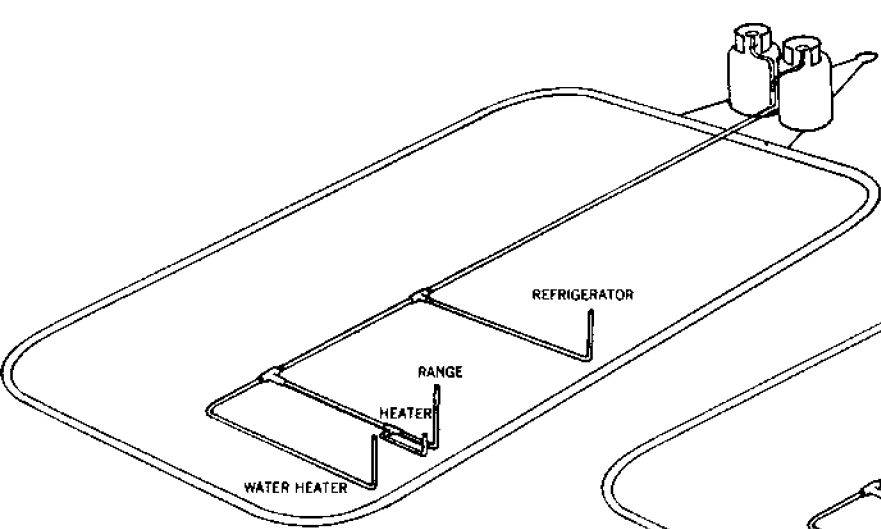

17

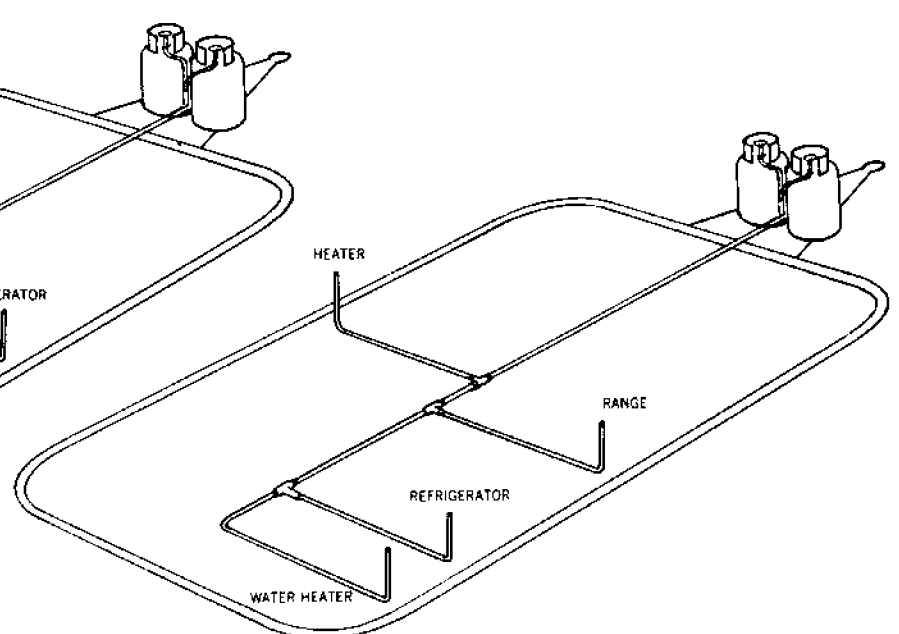

20

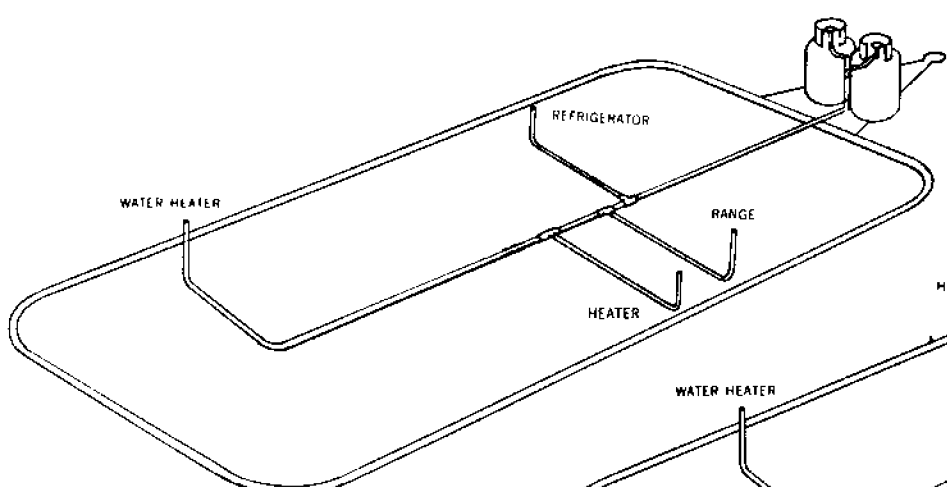

22

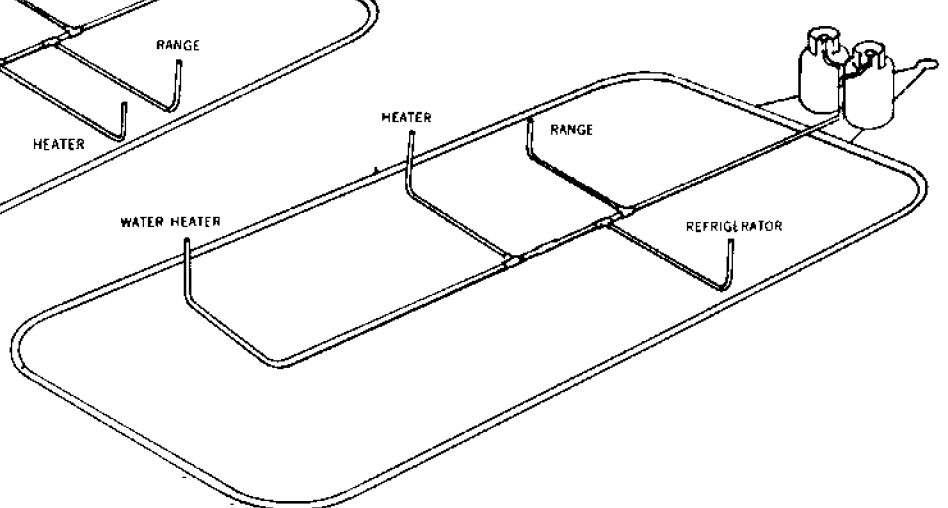

24

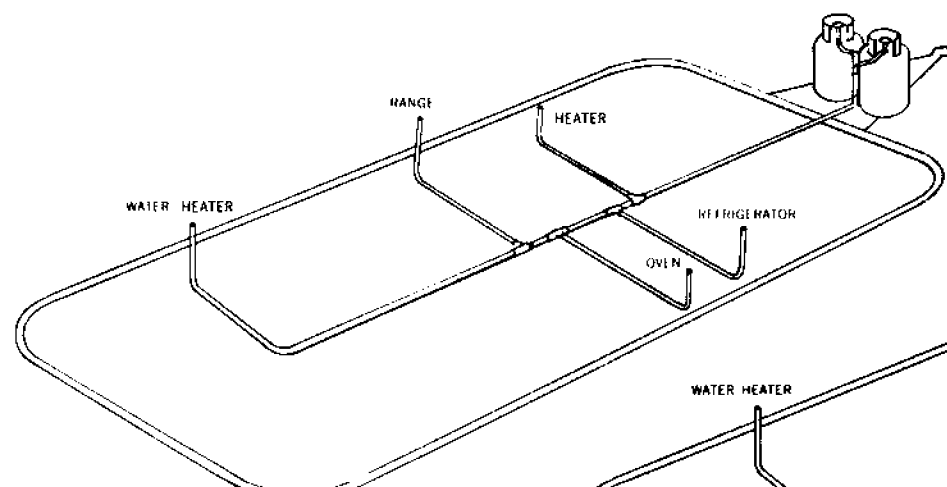

26T

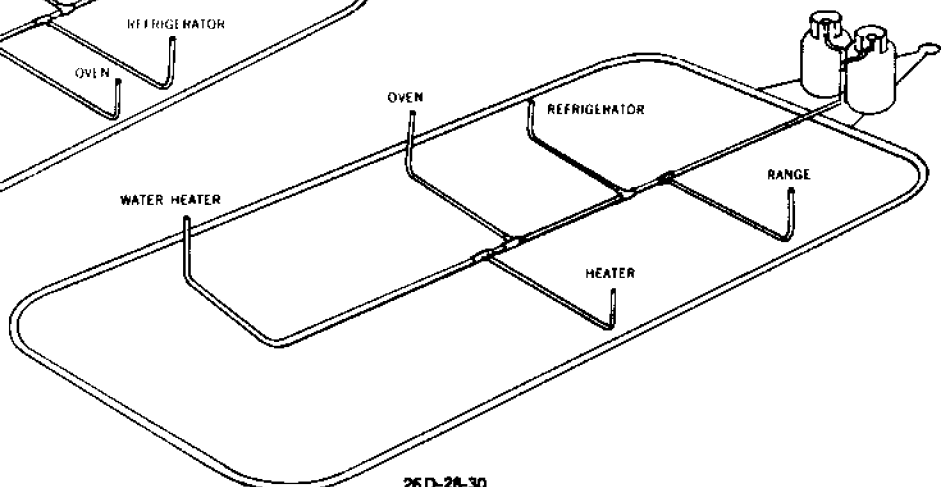

26D-28-30

CHAPTER 7

THE RANGE AND OVEN

Your Airstream is equipped with a Magic Chef gas range and oven. Following are some hints on how to keep them operating at their best.

RANGE

1. Your range is equipped with coaxial orifices for use with LP gas. The flame will be approximately ½-inch long.
2. Air shutters on top burners are to be adjusted so that each cone of the flame is separate and distinct and appears as illustrated in Figure 7-A. Air shutters set too far open will cause flame to lift away from burner head and will be difficult to light. If air shutters are closed too much the flame will look hazy and the distinct cones will be missing.
3. On all trailers except the 26-, 28-, and 30-foot models, adjust the top pilot so that the tip of the flame is just over the edge of the inner cone. The burners should light within 4 seconds. If lighting is difficult, refer to No. 2 above.
4. On 26-, 28-, and 30-foot models, never allow the top cover to be closed while the stove is in operation, as this will extinguish the flame and permit the gas to escape into the trailer.

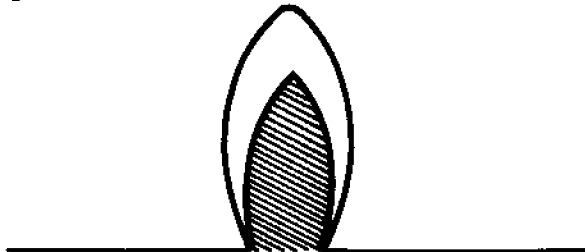

FIGURE 7-A

TROUBLE SHOOTING

Trouble — Flames “Lift Off” Ports

Cause: Too much air, gas, or both.

Remedies: Decrease air, gas, or both.

Trouble — Soot formations

Cause: Too much gas or not enough air.

Remedy: Decrease gas or increase air.

Trouble — Burner noisy when extinguished

Cause: Too much air.

Remedy: Readjust air shutter.

Trouble—Flame flashes back into air mixture chamber

Cause: Too much air in proportion to gas.

Remedy: Slightly increase gas or decrease air.

Trouble — Orange Flame

Cause: Small filings in new burners or dust in air.

Remedy: If trouble persists clean burners.

Trouble — Burner fails to light

Cause: Usually too much air.

Remedy: Decrease air.

OVEN SECTION

1. To adjust pilot: (refer to Figure 7-B)

The automatic oven burner pilot in your oven consists of two separate pilots, a small constant pilot and a larger heater pilot. The constant pilot, which should be burning at all times when parked, ignites the heater pilot in the oven burner. To adjust the burner: Open pilot valve (A), light constant pilot (B) with match and adjust pilot valve (A) by reducing flame on constant pilot (B) until yellow tip disappears.

To adjust the heater pilot turn control knob (C) to 300° on the temperature setting on the control knob dial. This will permit gas to flow through the heater pilot tube (D) to the heater pilot (E) where gas is ignited by the constant pilot (B).

Remove control knob (C) and bezel (CC) and adjust heater pilot gas supply by turning green heater pilot adjusting screw (F) on front of control valve until flame on heater pilot (E) yellows. Then close adjusting screw until yellow tip disappears. Replace bezel and control knob.

IMPORTANT: YOUR OVEN IS EQUIPPED WITH A SAFETY IGNITION THAT REQUIRES A MINIMUM OF 30 SECONDS TO OPERATE AFTER TURNING OVEN KNOB ON. THE OVEN PILOT MAY BE SLOW IN LIGHTING DUE TO AIR IN GAS LINES.

2. To adjust main burner:

Your oven is equipped with a coaxial orifice for use on LP gas. The main burner when adjusted to the proper rate will have a flame approximately ¾-inch long. The air shutter on the main burners should be adjusted so the cone of each flame is separate and distinct. See figure 7-A.

IMPORTANT: The thermostat on your range does not have a by-pass setting. It will cycle off and on at all temperature settings. No by-pass adjustment is necessary.

CLEANING INSTRUCTIONS AFTER RANGE IS IN USE

1. To assist in cleaning the area around the top burners, on all models except 26-, 28-, and 30-foot, the main top has been hinged from the back so that it can be raised. Care should be taken during the cleaning operation that you do not touch the hot pilot shield. Also, when the cleaning operation is completed, be sure that the flash tubes are back in place.
2. If top burner heads are cleaned with any cleaning compound, care should be taken to see that all ports are opened up with a toothpick to assure proper operation. It is especially important that the lighter ports on the side of the burner head are kept clear.
3. Spill overs or spotting in oven or broiler are more easily removed when done promptly after they occur. Never wash porcelain when warm. Never use cleaning powder containing grit or acid.

NOTE: If oven bottom is removed for cleaning or servicing, be sure that oven bottom is locked in place when it is put back in the range. The front return flange on the oven bottom must hook under the side support angles to prevent warpage.

NOTE: The range gas line shut off valve located under the top of the range must be turned off when towing the trailer, when changing the gas tanks or if the gas supply is turned off for any reason. Be absolutely sure oven pilot light has been relighted as soon as range valve is turned on.

On 26-, 28-, and 30-foot models the oven gas shut-off valve is the left-hand knob on the face of the oven. It should be turned off when traveling, or when gas tanks are being changed. You need not re-light the pilot unless you want to use the oven.

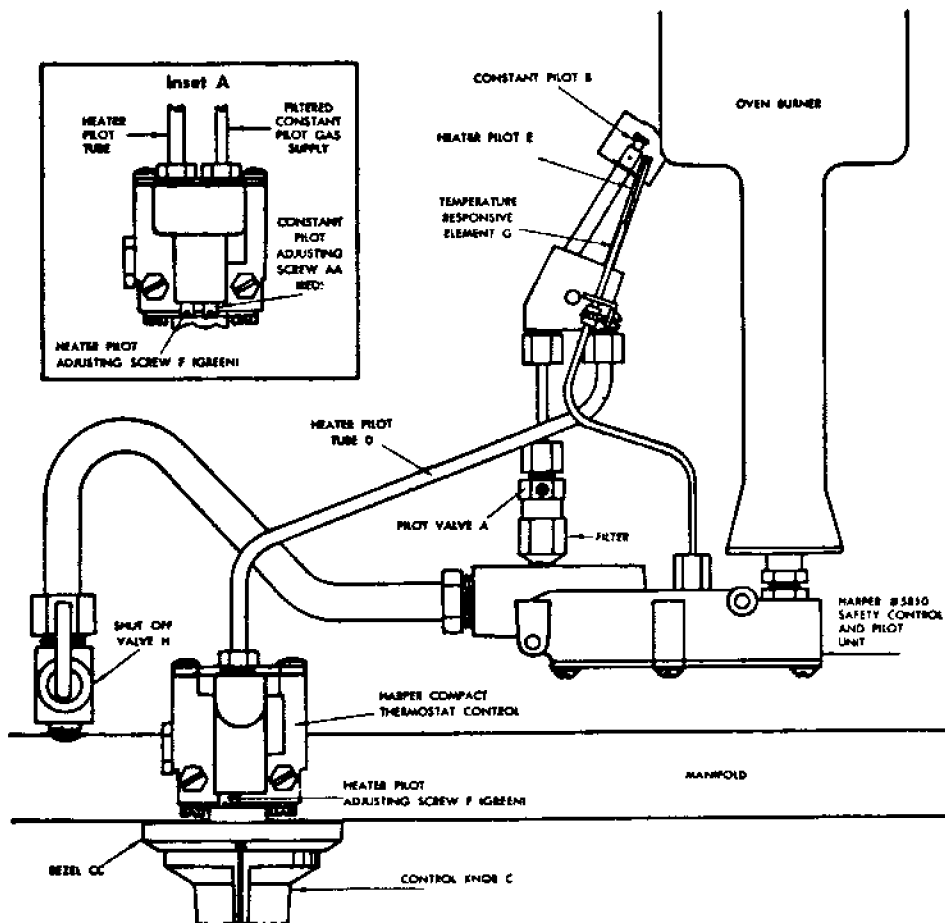

FIGURE 7-B

THE REFRIGERATOR

Your Airstream is equipped with an A.G.A. approved Dometic gas-electric refrigerator (gas only in the case of the 17' Caravel). These are the finest refrigerators available for travel trailer use and will give you many years of faithful service.

Whenever you park your trailer care should be taken that it is accurately level for best operation of this refrigerator. When parking try to avoid having a strong wind blowing directly against the wall where the vent outlets are located for most efficient operation. A spirit level has been provided with your Dometic refrigerator to assist you in leveling your Airstream. However, the job will be somewhat easier if you purchase two small inexpensive 10 to 12-in. spirit levels and lay them at 90° angles on the floor when you are leveling your Airstream.

The refrigeration system is air cooled. Therefore, it is of the utmost importance that air circulation around the cabinet is non-restricted.

Fig. 8A is an illustration of the working parts of your refrigerator which will be referred to in the following operating instructions.

LIGHTING THE BURNER

The gas tap must always be fully opened whenever the refrigerator is in use. A partially opened tap effects no saving and may interfere with the operation of the unit.

To light — Remove kick plate on bottom front of refrigerator by pulling outward

1. Turn gas valve lever "A" one-half turn clockwise to the open position. Push electric switch "F" down to "Off" position (except in 17' Caravel). Turn thermostat knob "B" to a setting of 4.
2. Press red button "C" and after about 15 seconds (to allow sufficient gas to enter), rapidly twist lighter rod "D" clockwise. This will create a spark which will ignite the gas.
3. After the burner has been lighted, keep button "C" depressed for an additional 15 seconds to allow the safety shut-off to become heated sufficiently to keep the valve open.
4. Release button "C" and check to make certain the burner remains lighted. If it should go out, repeat the above procedure and hold the button a few seconds longer.

Incorporated in the burner bracket is an automatic

flame failure device which allows gas to pass only when the burner is lighted, keeping the thermocouple hot. Should the flame be blown out, the thermocouple will cool and the device will cut off the flow of gas to the burner.

IMPORTANT— always make certain that electric switch "F" is off before operating the refrigerator on gas (all models except 17' Caravel).

FOR ELECTRIC OPERATION (all models except 17' Caravel)

1. Push Switch "F" up to the "ON" position and turn gas lever "A" counterclockwise to the "OFF" position.
2. Check to be sure the electrical cord is plugged into its 110-volt convenience outlet.
3. Turn the electric thermostat to a setting of 4. The refrigerator is now in operation.

THE THERMOSTAT

This refrigerator has automatic thermostatic control of the temperature in the food storage space. The gas thermostat (GT) controls the temperature during gas operation, while the electrical thermostat (ET) controls the temperature during electric operation. Be sure to make the temperature setting on the correct thermostat.

As soon as the required cold temperature inside the cabinet is reached, the thermostat cuts the burner main flame to the by-pass flame sufficient to keep the safety valve open during gas operation. During electric operation the thermostat cycles the flow of electrical current to maintain the set temperature.

DEFROSTING AND CLEANING

Excessive formation of ice on the evaporator reduces refrigeration efficiency. It is, therefore, necessary to defrost the Unit whenever ice has accumulated.

When defrosting is necessary, turn the thermostat (ET or GT) to warmest position and leave the door of the refrigerator open. See that the drip tray is in its position below the evaporator.

This is a good time to remove all food and clean the interior and all other plastic parts with warm water adding detergents. Never use abrasive or caustic

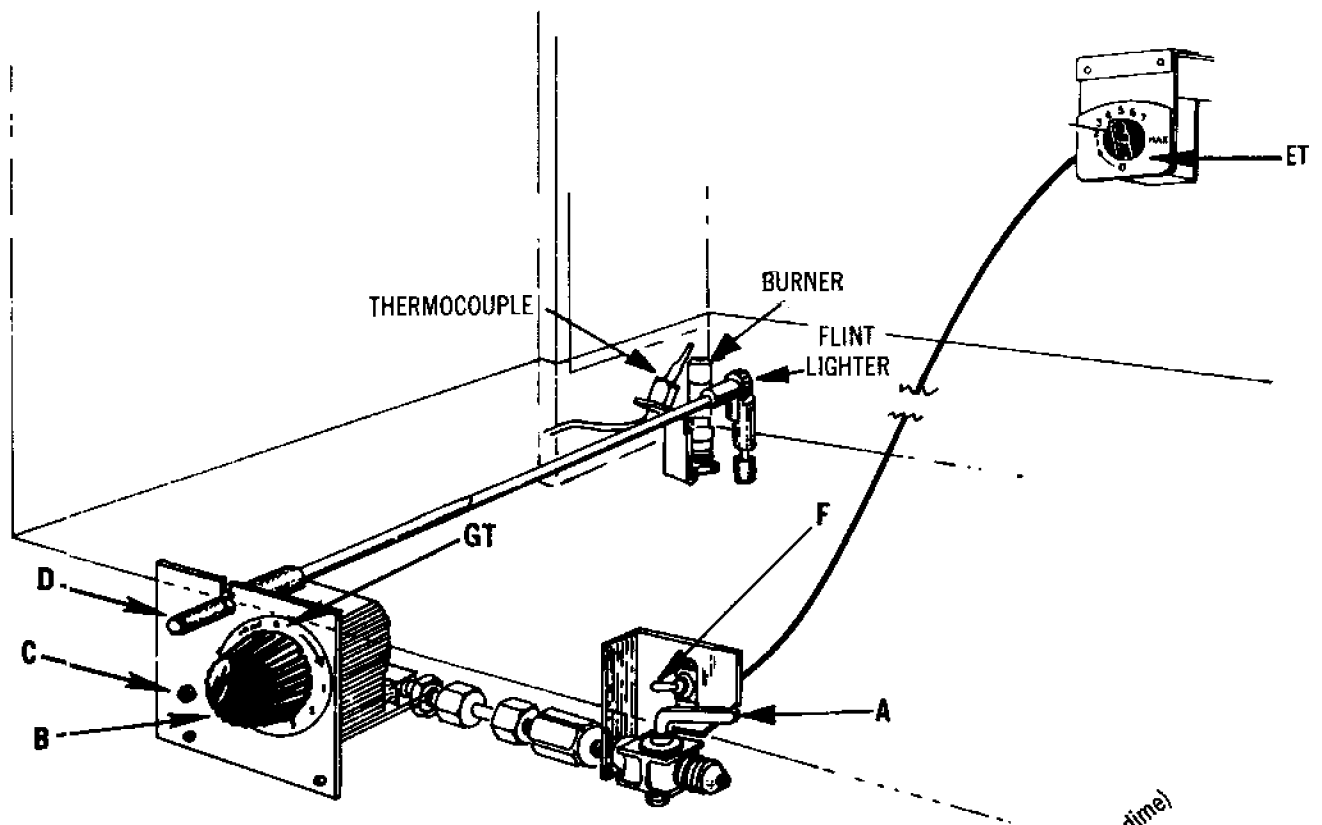

FIGURE 8-A

cleaning powders, polishes, cleaning paste or any gasoline, turpentine and the like.

Use a damp cloth for cleaning and finish with a soft dry cloth. After the defrosting has been completed, turn the control knob to its normal position.

When the refrigerator is to be out of operation for some time, always leave the door slightly open or place a pie tin with some barbecue charcoal on the shelf.

TROUBLE SHOOTING — GAS OPERATION

Trouble — Flame is noisy with buzzing sound

CAUSES AND REMEDIES

- a. Burner is getting too much air. Screw the lower air adjustment ring "A" on the burner down, to partially cover the air holes at the base, until the noise stops. (Figure 8B). Lock in position with the upper ring "B." Make certain that the flame remains blue. Blocking the air holes "C" completely will cause the flame to become yellow and to smoke.

Trouble — When lighting the gas flame it goes out as soon as the push button is released

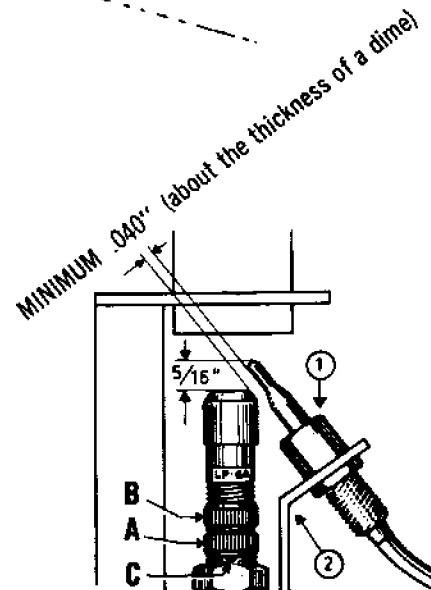

FIGURE 8-B

CAUSES AND REMEDIES

- a. The thermocouple tip may not be in the flame. The thermocouple should be at an approximately 45° angle to the burner located per figure 8-B.

Trouble — Flame goes out

CAUSES AND REMEDIES

- a. Flame blow-outs can be caused by excessive wind. If there has been no wind to cause the flame to repeatedly go out, go to a Dometic Service Depot to have the thermocouple and safety valve checked.

Trouble — Overfreezing

CAUSES AND REMEDIES

- a. The thermostat sensitive tubing is incorrectly located in the pocket inside the ice making compartment. Push the tubing back as far as it will go.
- b. The thermostat is out of adjustment. To adjust it turn the dial to "zero." If the flame does not go down to the "low" by-pass setting, follow this procedure:

- (1) Unscrew the large cap screw at the rear of the thermostat and remove the ball. Clean seat and ball and replace.
- (2) If procedure (1) does not correct the problem, remove the dial knob with the dial plate and turn the exposed set screw out (in counter clockwise direction) until the flame goes down to the by-pass.

- c. If the flame keeps going out when the dial is turned to (O) remove and clean the by-pass screw which is located inside the gas connection on the left side of the thermostat.

Trouble — Burner does not light

CAUSES AND REMEDIES

- a. Remove and clean burner barrel.
- b. Check gas supply.

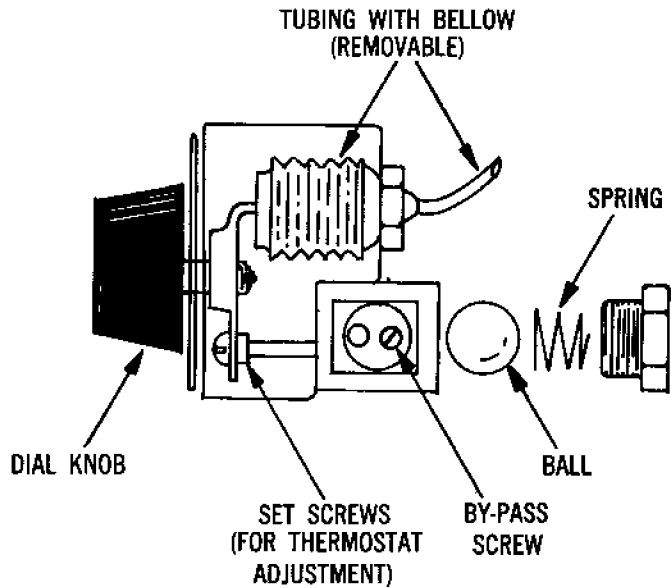

FIGURE 8-C

CHAPTER 9 THE FURNACE

The furnace in your Airstream is a Suburban Model No. NT-20, a sealed combustion system furnace approved by the American Gas Association for safety and performance for installation in travel trailers.

This furnace utilizes a sealed combustion system with a patented dual blower. One blower circulates room air while the other furnishes outside air for combustion. The combustion air blower then forces the flue products to the outside for maximum safety and heating efficiency.

The unit incorporates an advanced design for circulating the warm air. All trailer models (except the 22-foot) have registers located at both ends of the trailer. These are **return** registers; their function is to draw cold air in, rather than blow warm air out. Heat comes only out of the furnace itself, and is circulated inside the trailer by the action of the blower. Do not expect to find warm air coming from the registers. The 22-foot model is so designed that these registers are not required. Ducts integral with the furnace itself supply the volume of air needed.

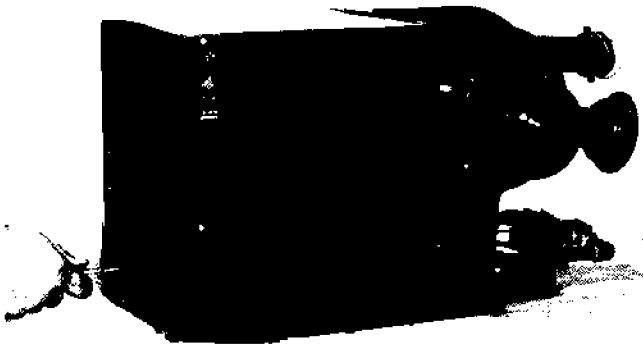

Fig. 9A

TO OPERATE

To light the heater, turn the manual valve to the "On" position and set the thermostat at its lowest setting. Remove the front grille, unscrew the lighter opening cover, and insert a burning match through the opening so the flame is near the pilot. Press the reset button (see Fig. 9A) and hold. On the initial lighting, the pilot may not light immediately due to air in the gas line. If such is the case, it may be necessary to hold the reset button in for a minute or more before the pilot lights. When the pilot is burning, continue to hold the reset button in for approximately 30 seconds. The pilot should then continue to burn when the reset button is released. Install the mica lighter opening cover and turn the thermostat up. The heater is now ready for

observation and adjustment of the main burner primary air.

The heater should be set in operation by advancing the thermostat, and should be allowed to run for at least 10 minutes, or until it reaches near-maximum operating temperature. If the flame burns yellow or jumps off the port, the primary air may need adjustment. The air shutter should be adjusted to the point where a slight trace of yellow remains in the tip of the flame. This is the proper adjustment. Final observation should be made with the cover in place, at which time the yellow tips should have disappeared. **CAUTION:** It should be remembered that the lighter opening cover and the primary air adjustment cover must be in place for proper operation of the furnace.

Since the heater was tested at the factory before shipment, it may be found that the primary air is already in proper adjustment. **NEVERTHELESS, IT IS RECOMMENDED THAT THE ADJUSTMENT PROCEDURE OUTLINED BELOW BE CARRIED OUT.** The burner adjustments may vary from one location to another due to difference in elevation as well as difference in characteristics of fuel gases.

To adjust primary air, remove the front of the unit and take out the screws that retain the rectangular cover plate (see Fig. 9A). Inside the opening created by removing the rectangular cover plate is a threaded rod with the visible end slotted. This rod controls the position of the main burner primary air shutter. With a screwdriver, turn the rod counterclockwise for less primary air or clockwise for more primary air.

In isolated cases it may be found that a difference in pressure between the air in the room and the air outside the trailer will cause a strong draft through the heater when the lighter opening cover is removed, resulting in a difficult lighting operation. When this condition exists the pressure may be equalized by opening a window or door as near as possible to the heater. The desired result may not be obtained unless the door or window is on the same wall as the heater. After the pilot has been lit and the lighter hole cover replaced, this difference in pressure will not affect the operation of the heater.

SEQUENCE OF NORMAL OPERATION

When the thermostat calls for heat, the blower motor is energized immediately. As the blower reaches approximately 75% of full speed, a microswitch will engage, opening the solenoid valve, and thus turning on the main burner. If within a period of approximately

two minutes after the main burner is lit, the thermostat is turned back, both the motor and solenoid valve are de-energized. However, if the heater is allowed to operate longer than the period of approximately two minutes, a slight snap can be heard from within the casing. This snap is caused by the fan switch as it changes its position. After this occurs, if the thermostat is turned back (or when the thermostat is satisfied), the solenoid valve will close, the flame on the main burner will go out, but the blower will continue to run. The purpose of this is to remove most of the remaining heat from the heater as well as purge the combustion gases from the heat exchanger. The blower will continue to run for a short time and will then shut off. It is perfectly normal for the blower to continue in operation for a time after the unit is theoretically "Off".

To shut the heater down, turn the thermostat to its lowest setting and turn the manual valve to its "Off" position.

REMOVING MOISTURE

When humidity is high inside your trailer, turn on the trailer exhaust fan in the roof vent and open a window slightly to get cross ventilation. This will not affect the operation of the furnace.

TROUBLESHOOTING

If the heater does not perform normally, the following discussion of some of the most probable causes and their corrections will be helpful.

If cool air is constantly discharged while the blower is in operation, it is obvious that the main burner is not on. This condition is caused by one or any combination of the following:

1. Pilot outage
2. Inoperative microswitch
3. Defective limit control
4. Defective fan switch
5. Loose connection in terminal block
6. Defective solenoid valve
7. Low supply voltage
8. Out of fuel

PILOT OUTAGE

Pilot outage is the most common cause of failure. If it is found that the pilot will not stay lit unless the reset button is depressed, a series of checks may be performed to quickly determine the cause.

The trouble is most likely in the thermocouple. First, check to see that the end of the thermocouple lead is

screwed firmly into the safety pilot valve and the joint is clean. If this is not the cause, the burner assembly should be removed. A visual inspection of the thermocouple may show that it is defective. If the copper sheath of the lead is broken or if the thermocouple tip shows signs of being bent or ruptured, it should be replaced with a new part. The new part must be of the same part number as the old one, or it may not fit or function properly.

Sometimes a safety pilot system will hold part of the time but will drop out during operation of the heater. This is commonly caused by either a weak pilot, a weak thermocouple, or a weak power unit in the safety valve. A simple but very effective check can be made to detect such a condition.

Light the pilot and allow it to burn for two or three minutes; then blow it out. With a watch with a second hand, measure the time required for the safety pilot valve to drop out. (This drop out is evidenced by a clicking sound from the safety pilot valve.) The time should not be less than 30 seconds. The test should be repeated to assure accurate results. If the drop out time is less than 30 seconds, it is recommended that a service representative be consulted.

In the case of low pilot flame, where the thermal element is not bathed in flame, the pilot may be too low. This is caused by either an improper adjustment, a partially stopped-up pilot orifice or pilot line, and possibly a partially blocked passage in the safety pilot valve. The pilot flame size may be adjusted by turning a small screw that appears in a brass fitting located along the left side of the heater, just inside the front grille and above the projection of the pilot.

A common cause of pilot failure, especially on LP gas, is in the failure or freeze-up of the supply pressure regulator. A pressure regulator is a throttling device. If only a pilot flame is being drawn through a regulator, it could and sometimes does allow higher pressures to build up. This may be for only a short period of time; for that reason it is often hard to detect. This condition is evidenced by a blowing hard blue flame. If such is suspected, it is recommended that the regulator be replaced with a new one. If the pilot should fail during operation, the cause could be that either the controls compartment back or the base of the blower assembly is/are not properly secured. This condition is evidenced by a floating main burner flame and sometimes by a strong undesirable odor from the heater.

DEFECTIVE MICROSWITCH

The microswitch operates in response to the current of air generated by the blower. Hence, if for any reason the air from the blower is not sufficient, the microswitch will not operate. This may be caused by dirt accumulation in the blower wheels or by damage or dislocation of the cabinet insulation so as to block passage of air. If the switch is activated by the air and fails to operate, it should be replaced.

DEFECTIVE LIMIT CONTROL

The purpose of the limit control is to turn off the gas to the main burner if for any reason the heater becomes excessively hot. Improper operation of the heater due to the limit control does not always indicate a defective control. If the circulating air is blocked or only partially so, the limit control will function and cause the main burner to cycle. Cycling on the limit is not always undesirable — if it happens only occasionally. This is a good indication of safe operation and will most likely happen on a cold day. If cycling happens too often or for an extended period, the circulating air system should be thoroughly cleaned.

If for any reason the limit control is found to be defective, there is no recommended method of repairing it. Because of its importance for safety reasons it should be replaced with a new one. **CAUTION: NEVER SHUNT THE LIMIT CONTROL EVEN FOR TEMPORARY OPERATION.**

DEFECTIVE FAN SWITCH

The purpose of the fan switch is to control the sequence of operation of the blower. In the cold position the contacts are closed. This allows current to be

supplied to the motor through the thermostat. When the combustion chamber heats up, heating the element of the fan switch to the operating temperature, the switch changes position to complete a circuit through the motor from a direct source. Because of this, the blower will continue to run as long as the combustion chamber is hot, even though the thermostat is satisfied.

If blower performance is other than described, or if the snap-over in either direction causes even the slightest interruption in the normal hum of the motor, the control should be replaced.

LOOSE CONNECTION IN TERMINAL BLOCK

If the heater does not function as described under "Sequence of Normal Operation," the most likely source of trouble is in a loose electrical connection. All wiring is furnished with a pressure-type terminal. The ends which engage with the terminal block are of the friction type and must be pressed securely into the opening of the block. In most cases the trouble is quickly located and corrected.

DEFECTIVE SOLENOID VALVE

Any evidence of improper performance may be checked by applying voltage directly to the leads. This voltage should, of course, correspond with the furnace rating plate data.

POWER SUPPLY

The furnace operates from a 12 volt DC battery power supply. As the battery voltage drops, the blower circulation system will decrease until the microswitch in the blower finally "drops" out. This condition prevents the furnace from operating until the rated battery voltage is restored.

CHAPTER 10 THE WATER HEATER

Your Airstream is equipped with a Bowen gas water heater which is built to give you long years of trouble-free performance. It has a 100% shut off safety valve which shuts off the gas supply in the event of pilot flame being extinguished and is equipped with either a Minneapolis-Honeywell or a General Controls regulator. It is lighted and serviced from outside through an access panel at the left rear of the trailer (right rear of the 17' Caravel).

Procedures for lighting or re-lighting are as follows:

Operating Instructions for Units Equipped with MINNEAPOLIS-HONEYWELL CONTROLS regulator (Figure 10-A).

Procedure for lighting or re-lighting:

1. Be sure the heater is filled with water and that all air has been vented from gas line.
2. Turn gas cock knob to "Off" position and temperature indicator to lowest temperature position.
3. Wait sufficient length of time to allow gas which may have accumulated in burner compartment to escape. (Approximately 5 minutes).
4. Turn gas cock knob to pilot.
5. Depress the knob, light the pilot burner, and hold the knob down for about 1 minute.
6. Turn the gas cock knob to ON.
7. Set the lever indicator for the desired water temperature.
8. To shut down the heater, turn gas cock knob to OFF position.

NOTE: For instructions on how to adjust pilot flame see page 10-3.

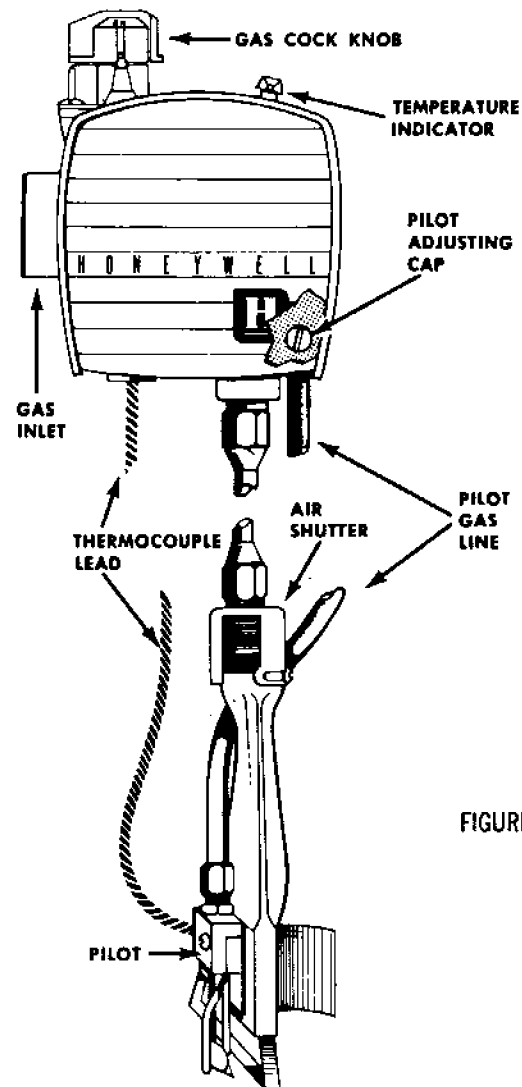

FIGURE 10-A

Operating Instructions for Units Equipped with GENERAL CONTROLS regulator (Figure 10-B).

Procedure for Lighting or Relighting:

1. Be sure that heater is filled with water and that all air has been vented from gas line.
2. Turn top dial to "Off" position, and temperature dial to lowest temperature position.
3. Wait sufficient length of time to allow gas which may have accumulated in burner compartment, to escape (Approx. 5 min.).
4. Turn top dial to "Light Pilot" and continue turning until dial "Stops." Hold in this position while lighting.

5. Allow pilot to burn approximately one minute before releasing dial from stop. If pilot does not remain ignited, repeat above operations allowing longer period before releasing from DIAL STOP.
6. Turn top dial to "ON" position and turn temperature dial to desired position. The main burner will ignite.
7. To shut down heater, turn top dial to "OFF."

NOTE: For instructions on how to adjust pilot flame, see following:

PILOT FLAME ADJUSTMENT

If the pilot flame does not have a small orange tip the pilot is not getting enough gas. (See Figure 10-C).

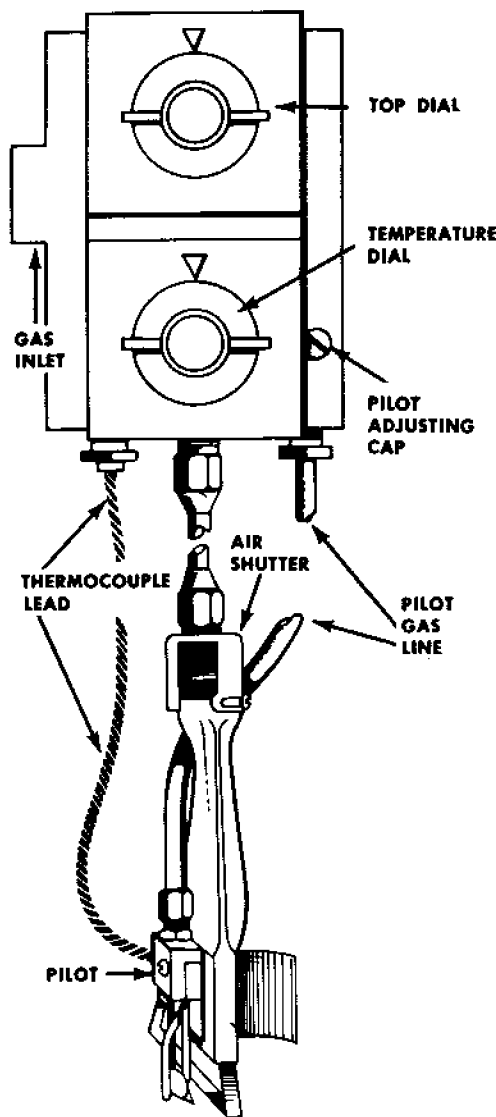

FIGURE 10-B

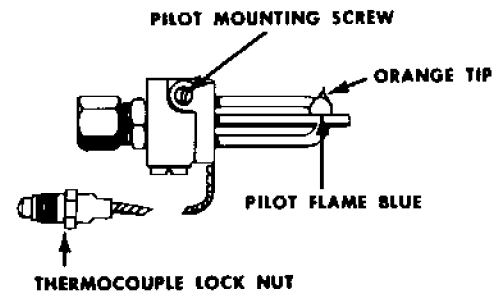

FIGURE 10-C

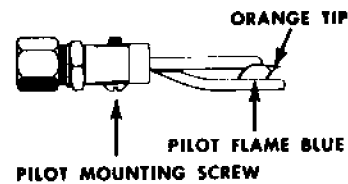

FIGURE 10-D

The flame should be about 1/4 of an inch in vertical height when the water in the tank is cold and the burner is off; and a flame 1/4 to 3/8 of an inch in horizontal length when the tank is warm. (See Figure 10-D). A large orange flame indicates excessive gas supply, which will result in short pilot life and early replacement. The pilot has been properly adjusted at the factory and should operate with a blue, orange tipped flame enveloping the pilot thermocouple. Removal of the "pilot adjustment cap" will reveal the pilot adjustment screw. Turning this screw clock-wise reduces the flow of gas to the pilot (blue flame) and counter clock-wise the gas supply is increased (orange flame). Always replace the "pilot adjustment cap" to prevent gas leakage.

AIR SHUTTER ADJUSTMENT

All fuels depend upon air (oxygen) to give them proper burning characteristics. A yellow, smoking flame indicates a lack of air and a noisy hard blue flame indicates an excess of air. The air shutter rotates around the main burner orifice holder and is held in place by a small shutter adjustment screw. Loosen the screw for adjustment. A good method of adjusting the air shutter is to rotate the shutter closed far enough for yellow tipping to occur on the main burner (not pilot) and then slowly open the air shutter until all signs of yellow tipping are gone. When proper adjustment has been obtained, tighten screw holding air shutter (See figure 10-E).

GAS LINE VENTING

Most failures to light are caused by the absence of gas

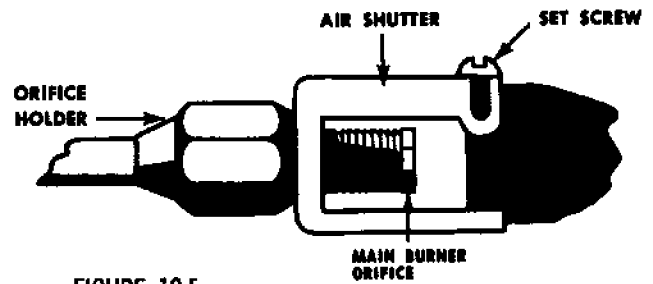

FIGURE 10-E

and presence of air at the pilot port. This may happen when you have run out of gas. Upon restoration of the gas supply the line is full of air. It is recommended that appliances such as the range and furnace be lighted first. This assures a supply of gas in the main gas line. Then follow the normal procedures as outlined previously for lighting.

THE ELECTRICAL SYSTEM IN YOUR AIRSTREAM

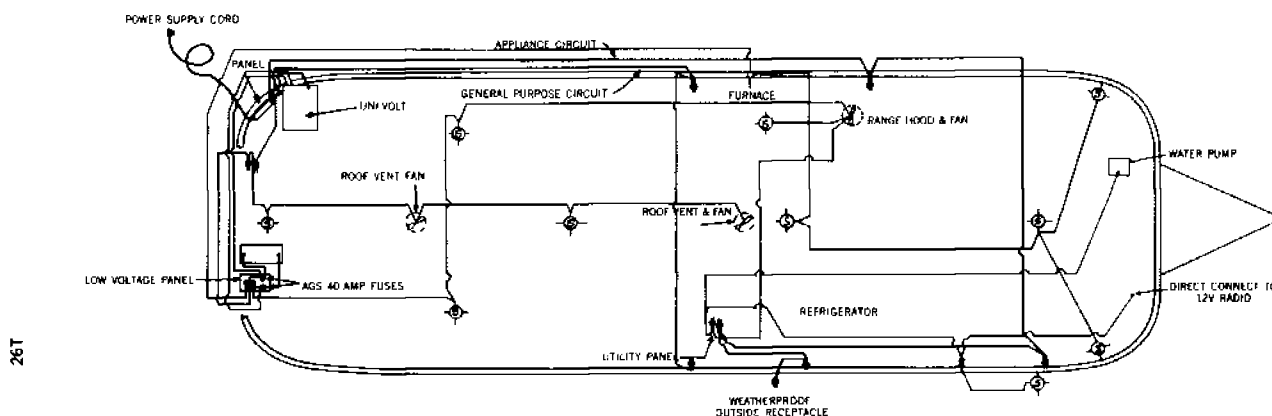

FIGURE 11-A

Your Airstream is equipped with the latest development in trailer electrical systems: the exclusive Airstream UNI-VOLT system. The lights and appliances — even the vent fan, range fan, and furnace air circulator—operate from the self-contained battery power without outside hook-up. When you are hooked up to city power, everything operates automatically on the 120-volt AC current. The UNI-VOLT system is made possible through the use of new 12-volt marine light bulbs that give the same light you would expect from regular household bulbs, and a special high-capacity combination 12-volt DC power supply and battery charger with all solid-state circuitry. Additional 120-volt AC convenience outlets are provided for operation of appliances such as TV, etc., when hooked up to city power. A wiring diagram of your Airstream is shown above.

The battery in your Airstream is a Prestolite, warranted for 24 months. For service or replacement, go to any service station or dealer displaying the Prestolite sign, or look in the classified section of your telephone directory.

As you drive, the battery in your trailer is under constant charge by your car's generator. The battery, your car's wiring and your Airstream's wiring are protected by a series of fuses, and by automatic circuit breakers which trip when a short or current surge occurs and go back into operation automatically when the trouble is corrected.

When you are operating your trailer on 120-volt city current, the wiring is protected by circuit breakers located in the panel box inside the rear wardrobe. In the event of failure of a 120-volt circuit, check the cir-

cuit breaker first. If the breaker continues to trip after you have re-set it several times, your circuit may be overloaded with appliances, or there may be a short in the circuit. If lessening the load on the circuit does not solve the problem, consult an electrician. In models with factory-installed air conditioning, a separate 120-volt circuit with separate circuit breaker is provided to avoid possible overloading of the appliance circuits.

WHEN YOU ARE OPERATING YOUR AIRSTREAM SELF-CONTAINED

All that is necessary to operate the UNI-VOLT system on battery power is to disconnect the power supply cable from the city power receptacle.

All 120-volt convenience outlets and the air conditioner, if you have this optional accessory, will now be inoperable.

TO OPERATE WITH CITY POWER

To operate the UNI-VOLT system in your Airstream from 120-volt AC city power, pull the power supply cable out of the storage compartment and plug in to city power.

NOTE: Be sure polarity indicator light is off when power supply cable is plugged in. (In the 20-foot model, the polarity indicator light is located in the frame of the access panel forward of the wheel housing on the left side of the trailer. In all other models, the indicator light is located in the One-Stop Service Center.)

As long as you are hooked into electrical service that accepts the three-prong grounded plug, you should not have a problem with polarity. However, in older parks and many other locations you will not be able to tie into three wire grounded service. In this event follow this procedure:

- a. Attach the three-prong plug on your trailer power supply cable to a two-prong adapter. The third conductor line from the adapter has a ground lug. This is your ground line.
- b. Clamp ground line to junction box or other ground such as a water pipe, then insert two-

prong plug into the receptacle.

- c. *After cord has been connected check the polarity indicator light. If it is on, pull out the plug, turn it over, and reinsert. The neon lamp will now be out, and the polarity will be correct. Your Airstream electrical system is grounded.*

It is necessary to ground the service coming into your Airstream to prevent a possible shock to anyone touching your trailer.

NOTE: Always make certain that the trailer park service is 120-volt, not 220V.

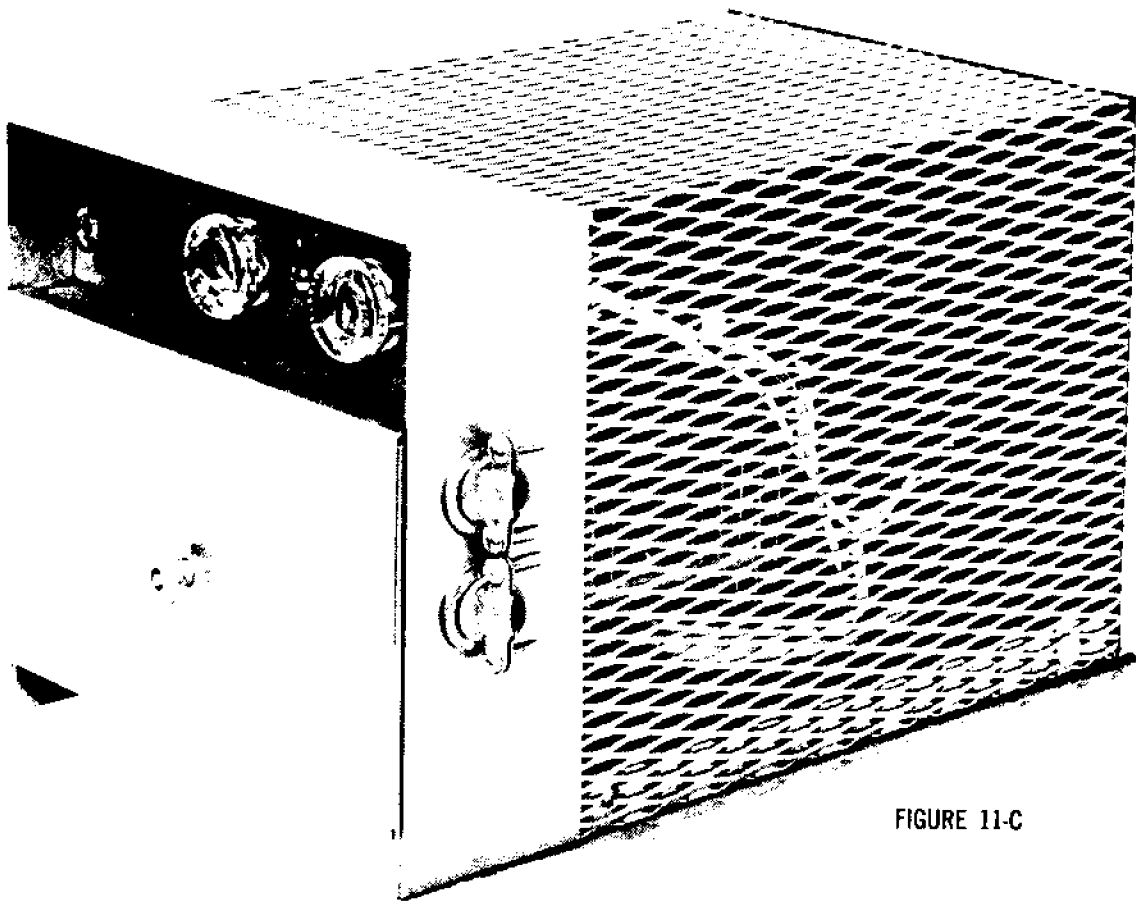

FIGURE 11-C

UNI-VOLT OPERATING AND SERVICE INSTRUCTIONS

Operating from a 120 volt line input, the UNI-VOLT will provide substantial current to a DC load while maintaining your 12-volt battery at a full charge condition.

The UNI-VOLT incorporates a unique voltage-sensing section in the charger circuit that automatically controls charging current. When the battery is fully charged, shut-off is complete; it is impossible to over-charge. Because of its ability to operate over a wide range of input voltage, and because charger shut-off

is 100%, no adjustments or controls are required, and none are provided.

All circuitry is protected from damage by internal devices or fuses. All fuses are standard automotive or household types and are readily available. The unit is UL-approved.

TROUBLESHOOTING

As with any mechanical or electrical system, malfunctions may occur in your UNI-VOLT system from time to time. Following is a checklist of likely causes of some of the commonest troubles.

SYMPTOM	POSSIBLE CAUSE	REMEDY
<p>NO LOAD VOLTAGE (LIGHTS, APPLIANCES DO NOT WORK)</p> <p>BLOWN LOAD FUSE</p>	<p>1. INPUT LINE AND/OR BATTERY NOT CONNECTED</p> <p>2. FUSE BLOWN</p> <p>3. OVERLOADED CIRCUIT (OVER 40 AMPERES)</p> <p>4. SHORTED LOAD</p>	<p>1. MAKE NECESSARY CONNECTIONS</p> <p>2. SEE NEXT 3 ITEMS</p> <p>3. TURN OFF SWITCHES TO REDUCE LOAD TO 40 AMPERES OR LESS AND REPLACE LOAD FUSE WITH A 40 AMPERE AGS FUSE</p> <p>4. CHECK FOR DEFECTIVE WIRING, LAMPS, OR MOTORS, AND REPAIR. REPLACE LOAD FUSE AS INDICATED IN STEP 3 ABOVE.</p>
BLOWN BATTERY FUSE	<p>5. SHORTED BATTERY</p> <p>6. SHORT IN WIRING BETWEEN BATTERY AND UNI-VOLT</p> <p>7. BATTERY TERMINALS NOT PROPERLY CONNECTED TO UNI-VOLT (+) AND (-) TERMINALS</p>	<p>5. REPLACE BATTERY AND BATTERY FUSE AS IN STEP 3 ABOVE.</p> <p>6. REPLACE OR REPAIR DEFECTIVE WIRING. REPLACE BATTERY FUSE.</p> <p>7. MAKE PROPER CONNECTIONS; POSITIVE BATTERY TERMINAL TO UNI-VOLT BATT. (+) AND NEGATIVE BATTERY TERMINAL TO BATT. (-). REPLACE BATTERY FUSE.</p>
BLOWN LINE FUSE	8. INCORRECT INPUT LINE VOLTAGE (SUCH AS 230 VAC OR 25 CPS LINE)	8. CONNECT TO 120 VAC, 60 CPS LINE.
DIM LIGHTS OR SLUGGISH FAN MOTOR	<p>9. LOW LINE VOLTAGE</p> <p>10. 25 CPS LINE FREQUENCY</p> <p>11. DISCHARGED BATTERY (WHEN OPERATING WITHOUT 120 VAC LINE)</p>	<p>9. USE LINE VOLTAGE OF 120 VAC ± 10 VOLTS.</p> <p>10. USE 60 CPS LINE FREQUENCY.</p> <p>11. CHARGE BATTERY.</p>
UNI-VOLT WILL NOT CHARGE BATTERY	<p>12. INPUT LINE NOT CONNECTED</p> <p>13. BATTERY NOT CONNECTED</p> <p>14. BAD BATTERY</p>	<p>12. CONNECT INPUT LINE.</p> <p>13. CONNECT BATTERY TO UNI-VOLT.</p> <p>14. REPLACE BATTERY.</p>
SPECIFIC GRAVITY OF BATTERY IS TOO HIGH (OVER 1.275)	15. BATTERY IS LOW ON WATER	15. ADD DISTILLED WATER TO BATTERY.

CHAPTER 12 THE WATER SYSTEM

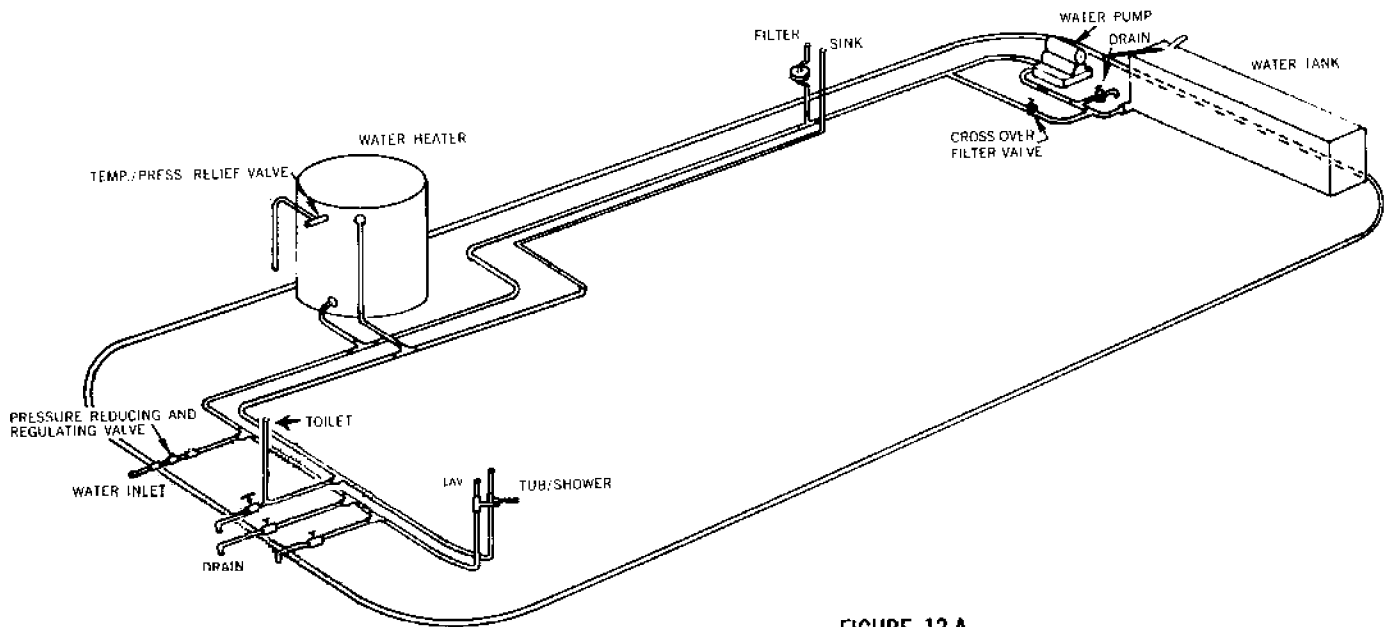

FIGURE 12-A

The water system in your Airstream trailer provides full service both when city water is available and when the trailer is operated completely self-contained.

When you are operating your water system from a city water service, connect a hose to the water entry fitting located on the left side of the trailer. Since the system is completely automatic, nothing else needs to be done before you utilize the entire water system, except to turn the switch on the water pump to the "Off" position.

If the water system has previously been drained it will be necessary for you to force the air from the water heater before lighting the water heater. Open a hot water faucet and allow all of the air to be forced through. If you plan to remain for some time where city water is available, drain the water storage tank and refill with fresh water before departing. Your system has check valves in the water lines to protect the water tank and, therefore *will not fill* while you are connected to city water, unless the crossover filler valve is opened. This crossover filler valve is located adjacent to the water pump underneath the front lounge on the left side of the trailer. It should always be kept in the "Off" position unless the water tank is being filled from the city water source. To fill the water tank when the trailer is connected to city water, merely turn this crossover valve to the "On" position and remove the filler cap from the water tank. Removal of the filler cap will preclude the water tank from being pressurized from the city water pressure, which could cause a potential failure in the tank.

If city water is not available, or will not be available at your destination, the Airstream self-contained water system may be used. The lightweight polyethylene water tank stores 30 gallons of tasteless, odorless, clean fresh water for all your needs. The new Airstream pressure-demand water pump runs whenever a faucet is open and shuts off almost immediately when the faucet is closed; silently delivering 4.3 gallons per minute under constant pressure. To fill the water storage tank, remove the filler cap and fill the tank with a water hose or bucket, or through the city water crossover valve as described earlier. The tank may be filled until the water entry pipe is overflowing. Replace the cap... the water system is now ready for use. Remember, if you have been hooked up to city water your tank *will not* have been filled, unless the crossover valve has been opened, so be sure to fill it before leaving. If the hot water tank was completely empty it must be refilled before lighting by opening a hot water faucet and waiting until water comes out the faucet.

The Airstream pressure-demand water pump is conveniently located under the left-hand side of the front lounge. To gain access to the pump, pull the lounge out, remove the filler mattress, and lift off the loose plywood cover on the left-hand side of the lounge. This will give complete access to the pump, the water tank fill valve, the drain valve, and the water screen. NOTE: before leaving your Airstream unattended for any length of time, it is advisable to turn off the water pump at the galley switch.

The water screen mentioned above should be cleaned periodically to prevent accumulation of dirt, sand, etc. The screen is located under the front lounge next to the pump. To remove it, disconnect the rubber hoses from either end, separate the screen housing, and lift the screen out of the compartment.

Due to iron and lime deposits which are found in various parts of the country, it is advisable to clean the tank occasionally. Pour some bicarbonate of soda into the filler pipe with several gallons of water and allow to stand for several hours. Flush out by opening the drain cock and running cold water through the tank.

Among the many fine accessories for an Airstream trailer is the HyPur water purifier at your galley sink. This remarkable unit is a complete water purification system that will provide crystal clear, good tasting and pure drinking and cooking water wherever you travel. It effectively removes all chlorine, organic odors, taste and most harmful bacteria.

It will be necessary to change the pack in your HyPur water purifier periodically with a type HP 10 replacement pack. These are available from your dealer, or accessory store. Instructions for changing the pack are in each box. It is a good idea to order packs two at a time so that you will always have a spare on hand.

Your Airstream is equipped with a water pressure regulator. This is an exclusive feature which protects the plumbing inside your Airstream from possibly excessive pressures which may be encountered in city water systems. The water pressure regulator insures that regardless of variations in the city water pressure, the water pressure at the faucets in your Airstream will always remain constant. If it should ever become necessary to adjust the water pressure regulator there is a screw adjustment located on the dome (see Figure 12-A). Turning this screw clockwise increases pressure — counter clockwise decreases pressure.

TROUBLE SHOOTING

Trouble — Pump does not prime

- a. Be sure there is water in the tank.
- b. Make certain battery power has not been exhausted.
- c. Check valve assemblies to make certain no foreign matter is between the valve and valve seat causing loss of suction. This is done as follows:
 1. Remove four slotted head screws (see Figure 12-B).
 2. Lift motor, drive, and diaphragm assembly off base.
 3. Lift valve assemblies from pockets and clean all foreign matter from valve and valve seat.

4. Replace valve assemblies back in the same pockets, being sure rubber valve is in UP on INTAKE SIDE and DOWN on EXHAUST SIDE.
5. Replace top assembly and bolt back together, being careful to tighten evenly.

Trouble — Pressure drops and pump kicks on periodically when water is not being drawn

- a. Check all connections and faucets for leaks. One drop of water per minute will cause the pump to run every two hours.
- b. Same as C above.

Trouble — Pump operation is rough and makes excessive noise

- a. After several months of operation, under certain conditions, the flow of the pump may become rough. If this happens the flow may be smoothed out again as follows: turn pump off, close inlet, open outlet, and with an air pump force air into system through the snifter valve (located at the rear of the unit on the intake side) until air comes from the outlet. Recap snifter, open intake and restart unit. Periodic attention should be given to snifter valve to see that valve core works freely and the hole in cover is kept open.

Trouble — Excessive belt wear (Not applicable to 17' Caravel)

- a. Adjust belt for proper tension. Belt has proper tension if it can be moved in and out on one side a total of $\frac{1}{4}$ " at a point half way between pulleys. To adjust belt: loosen nuts on end of motor and slide motor up or down until desired tension is attained, then retighten nuts.

Trouble — Pump runs frequently or constantly and there is no leak in the pressure side

- a. Check for an air leak on the suction side of the pump (between the tank and the pump). This will not damage the pump but will run the battery down.

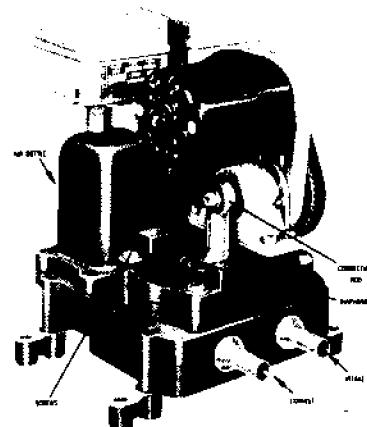

FIGURE 12-B

THE SEWAGE AND WASTE DISPOSAL SYSTEM IN YOUR AIRSTREAM

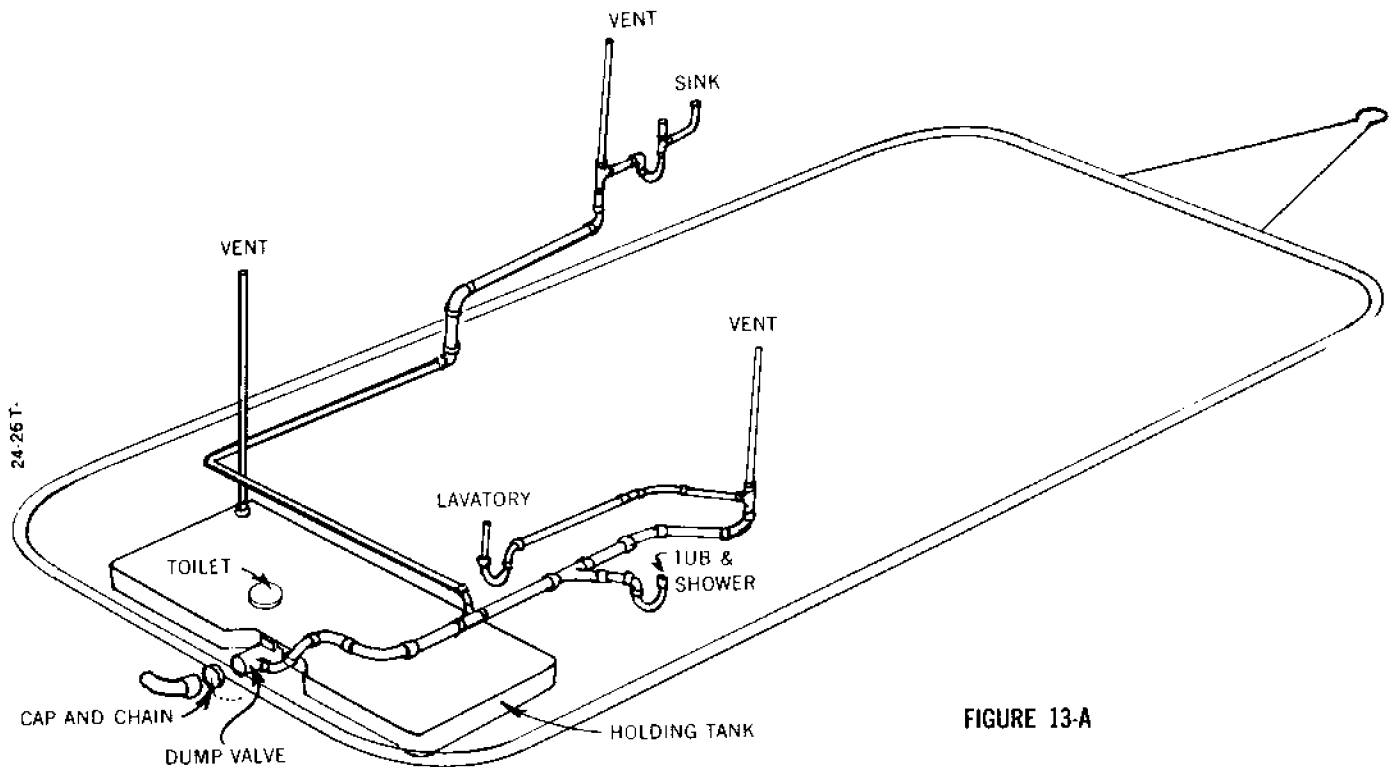

FIGURE 13-A

Your Airstream is equipped with a waste holding tank for sewage which permits use of the toilet for several days away from disposal facilities. The waste water from the sink, the shower, bath and lavatory all drain through the same outlet as the waste tank so you will need to make only one connection when hooking up in a trailer park. The diagram above shows the waste water disposal and waste holding tank in your Airstream.

The waste holding tank is made of seamless molded plastic, completely free from corrosion problems, with a specially designed dump valve for trouble-free operation. The best procedure for use of the waste holding tank when hooked-up to a sewer connection is to **keep the dump valve closed** and use plenty of water when flushing. This will prevent paper and waste material from building up at the valve causing the valve to close improperly and to leak.

When the toilet will no longer drain, the tank is full and must be emptied . . . watch this closely because when the tank is full the sewage cannot be emptied from the toilet bowl. To empty tank, attach sewer hose by pressing the fitting on the outlet and rotating until it feels solid and secure. Attach the outlet end of the hose to the sewage outlet making certain that the hose

is positioned so that it will drain completely. Pull the dump valve handle up as far as it will go and wait until the tank is drained. Refill the tank with 5-10 gallons of clean water and repeat the operation to insure that all paper and waste material has been flushed out. Close valve.

If you are moving on, place a small amount of clean water in your tank with some commercial cleaner such as TST so that it will slosh around and clean the tank while you are driving. The dump valve handle is equipped with a wire hold-down bail for positive protection against accidental release of the tank valve while driving.

In an emergency you can empty waste water from the sink and lavatory into your waste holding tank instead of allowing it to run on to the ground (some state parks forbid letting sink and bath water run onto the ground although it is often done in the wilderness. To empty waste water into the waste holding tank, open the dump valve while keeping the Sewage Line Drain Cap on. Waste water will automatically back up into the tank. Note: Water conservation must be practiced when allowing waste water to drain into the waste holding tank since it will fill rapidly.

After you have been emptying waste water into the

waste holding tank in this manner, when you arrive at a waste disposal facility, close the tank dump valve, place a bucket under the tank outlet and remove the Sewage Drain Line Cover Cap in order to drain the section of pipe between the cap and the valve.

USING A "GOPHER HOLE"

When you are parking in areas where it is permissible to do so, you may dig a "gopher hole" to dispose of the contents of your waste holding tank. To dig a gopher hole:

Dig a deep hole keeping the dirt you dig out in a large carton or box under your trailer. After the hole is dug, back your trailer up so that the toilet drain hose will drop straight down into the hole and so that the hole will not be where anyone could step into it by mistake. It is strongly recommended that you use an Airstream "gopher hole" cover . . . a plate which will cover the hole completely and that you can seal by piling some dirt around the edges (the hole in the plate will be just large enough to take the sealing ring you usually use to seal your sewer hose where it enters the trailer park sewage system.). Drain your holding tank the night before you leave; the ground will absorb most of the contents overnight and it will be much easier to fill in just prior to departure next morning. This will also enable you to dump your wash water in the gopher hole next morning.

Beware that rain surface runoff water does not drain into your gopher hole and cause overflow. Mound some dirt around the hole to avert this.

THE TOILET

The toilet in your Airstream is a Thetford Slide-O-Matic, designed expressly for travel trailers. It is warranted for two years against defects in materials and workmanship.

The Thetford employs a completely new principle: a sliding, self-cleaning, positive-seal blade, which replaces the conventional clapper valve. Odors cannot escape from the holding tank into the interior of the trailer. No metal parts come in contact with the sewage; no mechanical adjustments are necessary; there are no cavities or clearance chambers to become fouled. The unit uses less than two quarts of water for automatic flush.

OPERATION

To operate, step on the foot pedal and hold it down until the inrush of water cleans the bowl. When pressure is removed from the pedal, the unit will automatically shut off and refill the bowl.

MAINTENANCE

Little or no maintenance is required. Once-a-year oiling of linkage bearings and shaft is recommended.

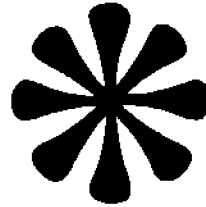

MAINTAINING

DO'S AND DON'TS

to make the most of your self-containment

by JACK KNEASS

As the story on these pages indicates, one of the great conveniences of traveling in a recreational vehicle is the self-containment offered. A RecV can literally be parked in the wilderness, yet offer all the comforts of home.

Strangely enough, it is this very feature of self-containment that leads the new owner, with no previous experience, into a trap. More queries for information about holding tanks, toilets, and pressure systems are received at TL than about any other item in the RecV.

A review of the questions asked makes this writer feel that a brief summary of do's and don'ts would save many newcomers to the RecV field a great deal of worry.

Don't, if you are self-contained with a holding tank, hook-up to a sewer line and have the valve open. The water-saving RecV toilet is not like a home toilet where a large volume of water is used at each flush. To leave the valve open is to invite deposits of solids in the tank, for the volume of water is not sufficient to carry all before it, as a home toilet does.

Do empty the holding tank every few days. Send a large volume of sewage through the tank and drain hose at one time, forcing solids into the sewer system.

Do, every few weeks or months, fill the holding tank half full of water and drive 50

miles or so over moderately rough roads before emptying the tank. If you want to be certain of cleaning out the tank, add a little soap before taking the drive.

Do, follow instructions, and pre-wet the bowl before using.

Do, if using a hand spray, make certain to use enough water after using to get the lower side of the slide valve clean.

Don't put facial tissue in the toilet. Facial tissue has been treated to ensure that it retains its strength when wet and will never dissolve in a holding tank.

Don't use detergents or bleaches. Detergents do no good, and actually remove lubricating oils and greases. If necessary, use a sewage tank deodorizer, which can be gotten from almost any dealer and all trailer supply stores.

Do winterize your trailer if it is to be parked for any length of time. Fill the tank half full of water. Drive a mile or so. Drain. Repeat the process twice more. Give it time to dry out, close the dump valve and add a little lubricating oil to the tank valve and toilet valve.

Drain or force water out of the toilet overflow trap with air. Drain the water from the inlet lines to your toilet.

If you follow these few simple rules you will never need to inquire where the nearest plumbing expert is.

EXTERIOR MAINTENANCE ON YOUR AIRSTREAM

Your Airstream has been protected by an acrylic lacquer finish applied at the factory. It will have on it an impervious film which should afford years of satisfactory service. As with any high quality finish, however, damage may occur if strong solvents or abrasive cleaners are used to remove road stains such as asphalt or insects. If use of solvents is necessary to remove these materials, the areas affected should be wiped with a good grade lacquer finish and touched up with a spray bomb of clear acrylic lacquer. If through the years the protective lacquer film is removed in extensive areas due to abrasion or highly corrosive atmospheres, a non-uniform appearance may result due to the differential oxidization of the underlying aluminum. Under these circumstances it is best to remove all lacquer with a good grade lacquer solvent and repolish the entire trailer as described below.

To keep your Airstream looking like new, it is important to keep the aluminum surface clean. Oils, greases, dust and dirt can be removed by washing with any mild non-abrasive soap or detergent such as those found around the house or those recommended for washing automotive finishes. (Automatic dishwasher detergents generally are too strong and should not be used). Under no circumstances should you attempt to use any of the acid etch cleaners that are available on the market as trailer cleaners. These are very dangerous for an amateur to use and, unless carefully handled, can be harmful to both the user and the trailer.

Cleaning solutions are best applied with a large sponge, soft cotton cloth or with a soft-to-medium bristle brush for stubborn spots. Cleaning should be followed by rinsing with clear water, taking care to rinse all detergent from cracks, grooves and crevices. Best results will be obtained by drying the surface with a chamois or soft cloth to prevent spotting or streaking. Always be careful to clean your Airstream in the shade or on a cloudy day and that the aluminum skin is not hot.

After cleaning and drying, a good grade of non-abrasive automotive paste or liquid wax will greatly increase the life of the finish, maintain a uniform overall appearance, protect the finish from minor scratches and abrasions, and make later cleaning and maintenance less frequent, less time consuming and less expensive.

Wax coatings should normally be applied every three to six months. They are best applied by hand but a soft, light-pressure mechanical buffer can be used if great caution is taken. Even non-abrasive waxes may cause surface marks if heavily buffed with high-pressure mechanical buffing equipment. The life of the wax coating is dependent on the degree and severity of exposure and maintenance between waxings. To get the longest life from wax coatings, excess grime and soil should be washed as often as needed with clean, cool water and the surface dried with a damp chamois or cloth. A protective wax coating is particularly important in seaboard localities where the finish is exposed to salt air, and in industrial areas where the finish is exposed to industrial waste fallout.

It is important to remove sap, seeds, gum and resin as soon as possible after they appear by washing and rewaxing. Sunlight and time will bake harden these materials so they may become ingrained into the actual finish of the aluminum, making them almost impossible to remove without heavy buffing.

If your trailer becomes exposed to unusually severe and corrosive atmospheric or service conditions, or has received improper or little maintenance, the acrylic coating may be destroyed and the aluminum may oxidize. This oxidization appears either visibly, as a white powder in very small granules, or can be felt as a roughness on the surface. To clean your Airstream after oxidization has taken place, the following procedure is recommended:

1. Wash your trailer with a good detergent using moderately hot water. Remove all dirt, mud and as much of the road asphalt as possible. If asphalt remains on the trailer after washing, use a small amount of kerosene on a rag and wipe the spots individually, being careful not to scratch the aluminum.
2. Remove all traces of the acrylic coating with a good grade lacquer solvent.
3. Use a ready made aluminum cleaning preparation such as those designed for use on aircraft. One that has been found to be satisfactory is **Met-All**. Use a fairly large, soft cloth spread with some Met-All and rub lengthwise on the trailer or parallel with the grain of the aluminum (you will be able to determine the grain of the aluminum by looking closely at each

panel). Do one complete sheet or section at a time.

4. Continue to rub the Met-All paste on the sheet after it has picked up a black color, which indicates that oxidization is being removed. Do not allow the rag to become caked or hard. Use either a clean rag or keep turning the rag as long as it is usable. When a cake of oxidized aluminum paste develops it is possible, with continued rubbing, to scratch the metal surface.
5. After completing the instructions under paragraph 4, use a soft, clean cloth that has been dusted with ordinary white wheat flour and buff off by hand the excess material that has been left on the sheet. (For extremely tough jobs it may be necessary to do a complete job twice, except that the second time it is not

necessary to wash the trailer with detergent).

6. The use of a buffer is *not* recommended except in the hands of a thoroughly experienced person (if not expertly used, the buffer will leave a pattern on the aluminum surface.

Glass Wax (made by Johnson) has been found to be very useful in removing the last marks made in rubbing off the oxidization. After it is thoroughly clean, the entire surface should be rewaxed. Do not use Glass Wax if you plan to re-coat your Airstream with the clear acrylic lacquer.

Special care should be directed to the exposed portion of the trailer frame, where it extends to the bumper at the rear. This should be protected from oxidation with a coat of aluminum paint at least once a year, and twice a year in a salt-air atmosphere.

CHAPTER 15

INTERIOR MAINTENANCE

The interior of your Airstream is designed to be as trouble- and maintenance-free as is possible. Following these tips will help maintain the interior of your Airstream sparkling new:

INTERIOR WALL FINISH

The interior finish is of vinyl, with the exception of the front end, which is of Zolatone plastic. The roof locker doors are also finished in vinyl.

An occasional washing with mild soap is all that is ever necessary to maintain the Zolatone finish. Although soaps will not harm it, avoid using detergents, as they can cause it to dry and flake.

Vinyl is best cleaned with a liberal application of suds from a mild household detergent such as Tide, with a small amount of bleach (Clorox, for example) added to the water. A damp bristle brush can be used for scrubbing to loosen and remove the soil. The surface should lastly be rinsed with clear water and wiped dry.

Note: use of kerosene, naphtha, carbon tetrachloride, lighter fluid, Energene, etc. should be avoided. They can cause damage to the vinyl. Abrasives should also be avoided, as they can wear off the print on unprotected surfaces and dull the lustre.

INTERIOR WOODWORK

The interior wood in your trailer is lacquered for greatest durability and beauty. A cloth moistened with plain water is the best cleaning agent. DO NOT use alcohol or any petroleum-base solvents; they will attack the lacquer and mar the finish.

FLOORS

Vinyl asbestos floor tile should be cleaned with warm water and detergent, and coated with a good grade of clear wax such as Johnson's Paste Wax or Vista wax. Self-polishing liquid waxes may be used, but they do not wear as well.

DRAPES & UPHOLSTERY

When storing your trailer it is a good idea to protect the upholstery from fading rays of the sun by putting aluminum foil between the window and the screen. Drapes and upholstery should be dry cleaned only.

WORK SURFACES

The work surfaces in your Airstream are of melamine laminate; they resist alcohol, fruit stains, scratches, acid, household alkali and heat up to 275°F. Waxing will help preserve the luster. Never use abrasive cleaners or use the surface for slicing or cutting. Protect from hot vessels.

PLASTIC BASIN AND TUB

The lavatory basin and tub in your Airstream are made of special, long-wearing plastic for light weight, high strength, and long life. When cleaning, use soap or detergent only — *never use scouring powder*. Wright's Silver Cream is an ideal cleaner for the plastic lavatory and skirt.

WINTERIZING YOUR AIRSTREAM

It is important to guard against freezing damage to the hot and cold water systems, the waste drain system (including the traps), the waste-holding tank, and the water heater. To completely winterize your Airstream, follow this procedure:

1. Level the trailer from side to side and front to rear. Open all the faucets on the inside and remove the hand filler cap.
2. Open all drain valves. There are three: two are located in the One-Stop Service Center, and one is at the water storage tank in front of the trailer. (In the 17-foot and 20-foot models, there are only two valves. In the 17', one is in the storage area under the lavatory, and one is inside the side trunk door. In the 20', one is in the storage area under the lavatory, and one is at the storage tank.)
3. While the water is draining from the system, open and close the toilet flushing valve. There is great danger of freezing if water remains in this valve.
4. After water has stopped running from the drain lines at the rear of the trailer, apply air pressure to the hot water drain line with all drain valves and faucets still open. This will force any remaining water from the water heater.
5. Pour about a cup of kerosene into the lavatory and sink drains to prevent freezing of water in the traps; or, drain them completely. Do not use anti-freeze.
6. Pour about a cup of kerosene into the shower or tub drain trap. (There is no effective way of draining it.) Do not use anti-freeze in the trap.
7. Be sure to open the waste-holding tank drain valve and drain the tank thoroughly. (This is very important as the sewage in the tank, if frozen, could seriously damage the tank.)
8. Lower the front of the trailer as far as the jack will allow and see if the water will continue to drain. Then crank the jack up as high as it will go and let any remaining water drain out.
9. Open all faucets inside the trailer.
10. Remove the lower portion of the water purifier, if your trailer is so equipped, and drain the purifier.
11. Turn the water pump switch to the "Off" position.
12. Disconnect the Inlet and Outlet connections and turn the pump by hand until all water is expelled.
13. Make certain that the battery in your trailer is up to charge to prevent it from freezing, or remove it for storage where it cannot freeze.

THE RUNNING GEAR (AXLES, WHEELS, BRAKES) AND MAINTENANCE

MAINTENANCE GUIDE

Item	Every 1,000 Miles	Every 5,000 Miles	Every 10,000 Miles	Procedura
Battery	X			Check water level—fill with distilled water only.
Smoke Hood Fan	X			Clean blades
Smoke Hood Filter	X			Wash
Hitch Ball Latch	X			Lubricate by coating with engine motor oil.
Hitch Jack	X			Lubricate with light household oil (put oil can spout up under handle and allow oil to run down post.
Window Operators/Slide	X			Lubricate with light household oil.
LPG Hold Down Screw	X			Lubricate with light household oil.
Entrance Door Hinge	X			Lubricate with light household oil.
Roof Vent Elevator Screws	X			Lubricate with light household oil.
All Exterior Door Locks	X			Lubricate by shooting in dry graphite.
Strike pocket on Exterior Door	X			Coat with paraffin.
Wheel Bearings			X	Clean, repack, and adjust.
Brakes			X	Inspect and adjust.
Tires	X			Inspect for foreign objects. Check pressure (45 psi except the Caravel which is 40 psi).
Tires		X		Cross-switch.
Water Pump		X		Check for wear and proper tension.

Your Airstream is without a doubt the finest, engineered travel trailer ever to be mass produced. Every step of the design and the choice of every component has been to give you thousands of miles of trouble-free operation. By following this minimum maintenance schedule you will enjoy all of the pleasure you dream of from your trailer . . . and more.

SEASONAL CHECK-UPS

Every fall and winter, and after any long storage, all of the gas appliances should be checked, cleaned and adjusted to insure safe and care-free operation. See chapters on individual appliances in this manual for maintenance procedures or have your Airstream dealer perform this "preventative maintenance" for you.

THE DURA-TORQUE AXLE IN YOUR AIRSTREAM

The Dura-Torque axle in your Airstream has been referred to by experienced trailerites as "the greatest thing that has happened to trailers since they invented the wheel." The Dura-Torque axle gives a much finer ride than the conventional axle and spring, and by elimination of the great number of parts, eliminates

sources of maintenance problems. The Dura-Torque axle is designed to last the life of your trailer without service except to the wheel bearings.

WARNING!

Under no circumstance, ever allow anyone to weld on the Dura-Torque axle (such as in mounting skids or welding in the area of the axle where the heat may be transferred to the axle). The heat generated by welding will destroy the rubber pads and cause failure of the axle.

One of the bonuses that result from having independent dura-torque suspension on tandem model Airstreams is the ease with which a flat tire may be changed. On a tandem trailer, to change one of the wheels it is necessary only to drive the remaining wheel on the same side up on a block about 4 inches thickness. The wheel with the flat tire will then clear the ground to a point where it is possible to remove it and replace it without the use of a jack. If a spare is not carried, it is quite possible to drive the unit for some distance on 3 wheels only.

THE KELSEY-HAYES ELECTRIC BRAKES ON YOUR AIRSTREAM

The Kelsey-Hayes 2-shoe adjustable brakes on your airstream are the finest electric brakes available on the market. They are operated by the 12-volt current on your car battery and can be hooked-up so that you have an integral system with your car brake.

The number one cause of trouble with trailer brakes is improper installation in the tow car. To prevent problems and insure satisfactory braking action it is necessary that you install a Kelsey-Hayes controller and a Kelsey-Hayes variable resistor in line with the brake controller in your car. Do not attempt to use any other brand.

Kelsey-Hayes publishes an excellent brake manual, a copy of which you will find in your trailer. It is suggested that you read it and follow the instructions completely.

To adjust your Kelsey-Hayes brakes is quite simple following this procedure:

1. Remove the small rubber plug at the base of the backing plate.
2. Use a brake-adjusting tool or a screwdriver that has been heated and bent to a 90° angle.
3. Jack the wheel up so you can spin it by hand; tighten the brakes, (using the previously mentioned tool) until the wheel is locked; back off until you have a free spinning wheel (which will be approximately 15 notches.)
4. Repeat this operation with all of the other wheels on your trailer.

THE TIRES ON YOUR AIRSTREAM

Your Airstream is equipped at the factory with Good-year 7:00x15 travel trailer tires (Caravel has 6:70x15 tubeless). Your Airstream dealer cannot make adjustments on these tires—they can be made by any Goodyear dealer. It is suggested that you contact your Airstream dealer who maintains a stock of tires for your Airstream. When you are on the road, if you have any problems with your tires, check in the classified pages of the telephone directory for the nearest Goodyear dealer. The following rules will help you get top

performance and maximum life from your tires:

1. Always check air pressure in your tires before starting on a trip. Tires should be cool when checked. Be sure you maintain correct pressure when cool, but never "bleed" air out after you have been driving or when tires are hot. The tires are designed to compensate for the higher pressure that will be encountered as they are driven; "bleeding" air out could result in under-inflation when they have cooled. The proper pressure for tires supplied with your Airstream (7:00 x 15) is 45 psi; (the 6:70 x 15 tires used on the Caravel are 40 psi.) Make sure valve cores and valve caps are tight to prevent loss of air. NOTE: Your Airstream tires are rated up to 60 psi and can be inflated to this pressure when the trailer is heavily loaded.
2. When parked between trips, maintain recommended air pressure in all tires at all times.
3. Whenever possible, park in shaded areas so that tires are not exposed to the direct rays of the sun.
4. If parking for extended periods of time, put your trailer on blocks so that tires do not touch the ground. If local parking regulations permit, and facilities are available, remove tires and store in dry, cool enclosure.

An over-inflated tire is weak and will wear more quickly than a properly inflated tire. When tires are over-inflated, a smaller portion of the tread is in contact with the road, reducing its ability to absorb road shocks and inviting blowouts.

Under-inflation always causes rapid tread wear and often causes premature failure. In under-inflation, as in over-inflation, only part of the tread is in contact with the road. (see illustration). Tires will wear abnormally and rapidly, with most of the wear taking place on the outer edges of the tread. Excessive heat builds up in under-inflated tires causing structural damage to the tire with the resultant danger of failure. The tires on your Airstream should be rotated regularly every 5,000 miles. If you carry a spare include the spare in the rotation. See illustration for recommended switching procedure.